

Signature Collection - Door & Partition System  
**Product Catalogue**

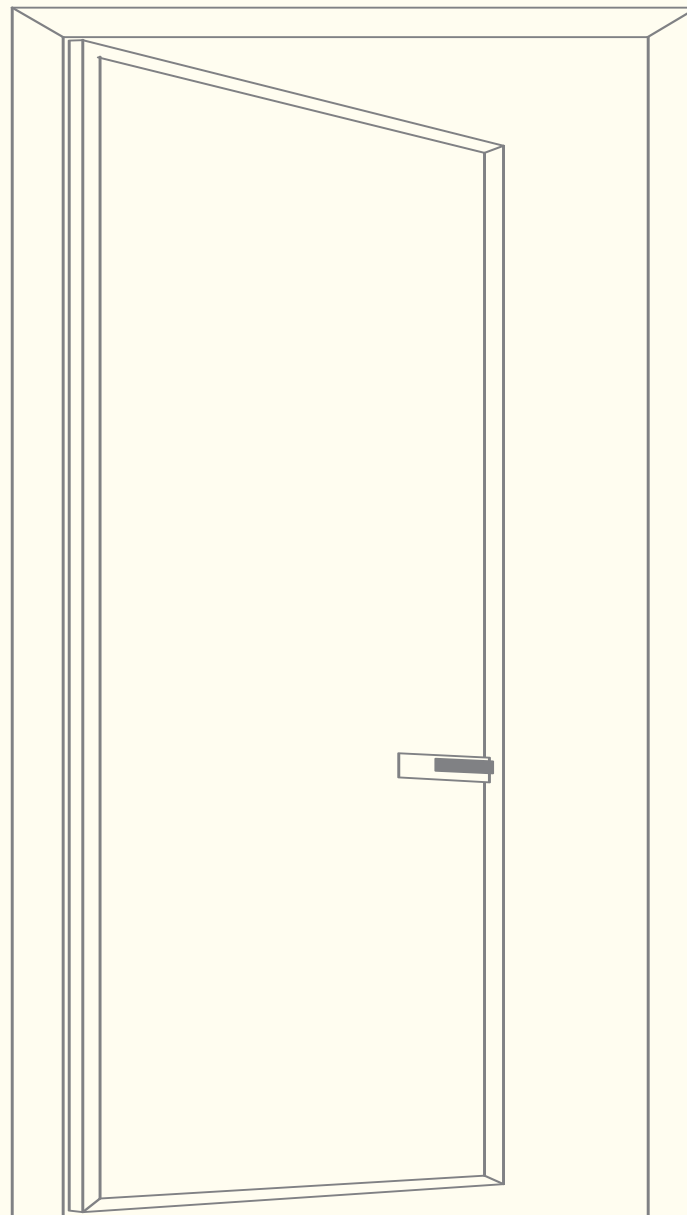

**THE ART  
WE OWN**

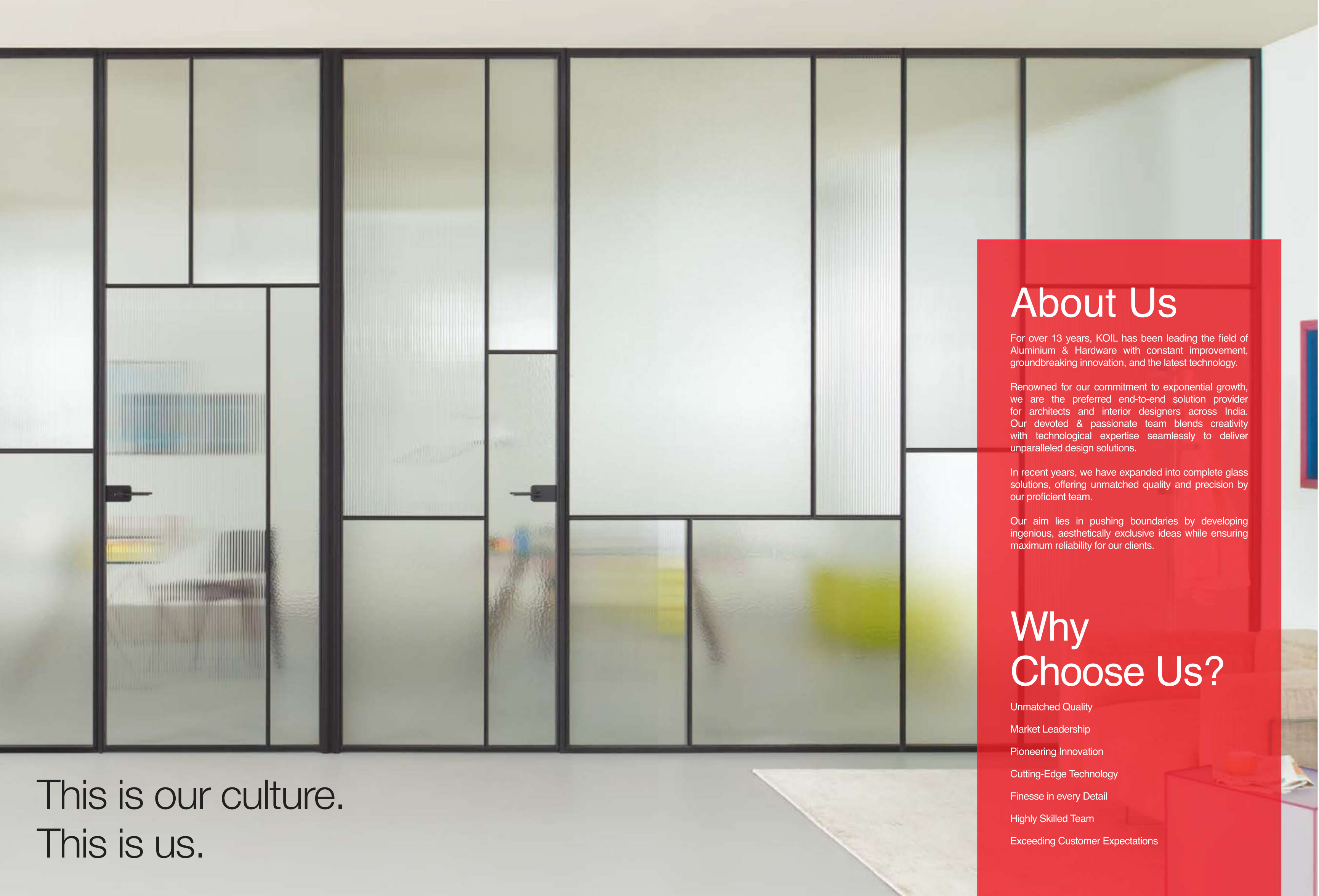

This is our culture.  
This is us.

## About Us

For over 13 years, KOIL has been leading the field of Aluminium & Hardware with constant improvement, groundbreaking innovation, and the latest technology.

Renowned for our commitment to exponential growth, we are the preferred end-to-end solution provider for architects and interior designers across India. Our devoted & passionate team blends creativity with technological expertise seamlessly to deliver unparalleled design solutions.

In recent years, we have expanded into complete glass solutions, offering unmatched quality and precision by our proficient team.

Our aim lies in pushing boundaries by developing ingenious, aesthetically exclusive ideas while ensuring maximum reliability for our clients.

## Why Choose Us?

Unmatched Quality

Market Leadership

Pioneering Innovation

Cutting-Edge Technology

Finesse in every Detail

Highly Skilled Team

Exceeding Customer Expectations

## PARTITIONS & SLIDING SYSTEM

**08**

Pocket Flush  
Series

**10**

Core Flush  
Series

**12**

Sail  
Series

**14**

Twirl  
Series

**16**

Drizzle  
Series

**19**

Aura  
Series

**24**

Linvisible  
Series

**29**

Solitaire  
Series

**34**

Double Glaze  
Series

**37**

Incline  
Series

**42**

Sleek  
Series

**47**

Vertex  
Series

**52**

Prima  
Series

**54**

Glaze Space  
Series

**56**

Grando Comfo  
Series  
(Pole System)

**58**

Grando Comfo  
Series  
(Back Panel  
Hanging System)

*Signature Collection*

Minimalist style design is a Kind of pursuit  
of perfect life attitude it is a concept of life in  
pursuit of taste

Index





**POCKET FLUSH SERIES**  
5mm Glass

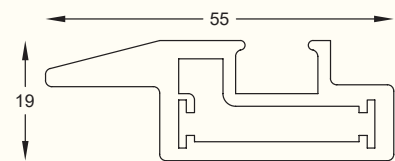

**SCP - 171**  
Frame Profile  
Size : 5.8 mtr.  
Finish : Black Matt, Champagne Gold Brush

Pocket flush Series exclusive black matt and champagne gold brush range as well as the custom made dimensions, are meant to serve a new concept of minimal design door, where each architectural element is fully customized, providing high stylistic coherence.

**POCKET FLUSH SERIES**



**OPENABLE FLUSH DOOR (WITH JAMB)**

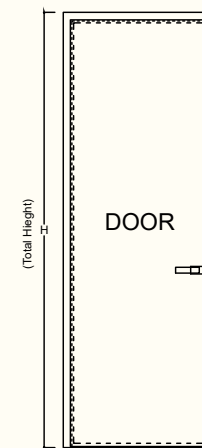
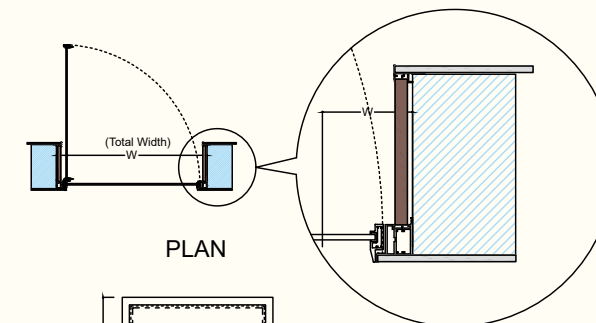

**ELEVATION**





# CORE FLUSH SERIES

5mm Products

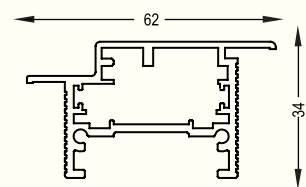

**SCP - 201**  
Aluminium Frame Profile  
Size : 5.8 mtr.  
Finish : Black Matt

Looking for the most premium door for your project? Discover Koil's Core FLush Series luxury doors made with quality material by our experts. Use the filters below to narrow down your search and find the interior door that fits what you have in mind. This design door can furnish the most diverse spaces thanks to well-selected any 5mm Surface that matches with the sophisticated elegance of wall.

## CORE FLUSH SERIES



## OPENABLE DOOR WITH FRAME

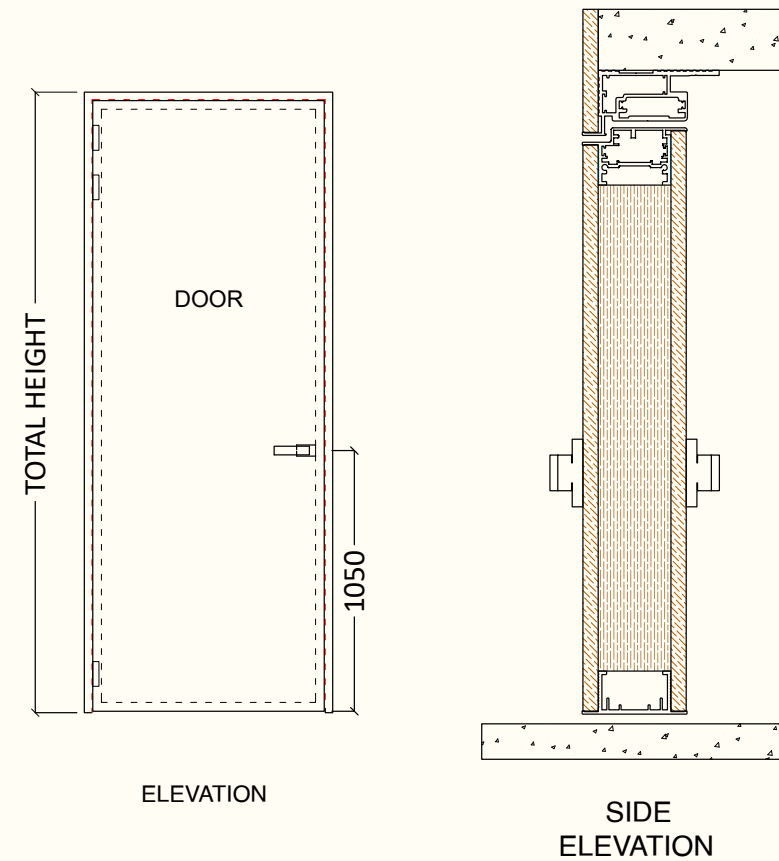
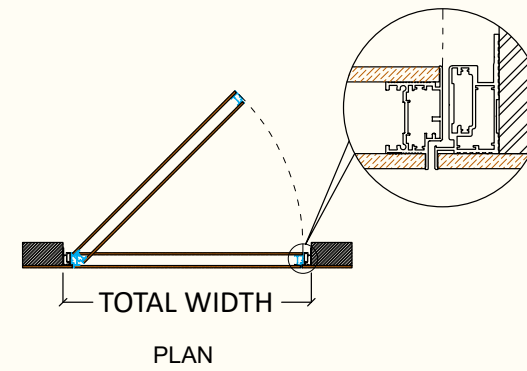





# SAIL SERIES

45mm x 18mm  
5mm/8mm Glass

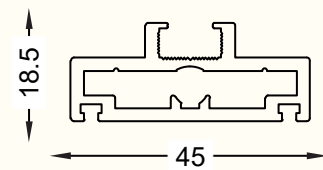

**SCP - 281**  
Frame Profile  
Size : 5.8 mtr.  
Finish : Black Matt, Gold Brush

Sail Series system of folding doors is born, designed to delimit, characterize and define also the most intimate domestic spaces. It retains the intangibility and lightness of the original collection, as well as the possibility of customizing the finishes in glass and aluminium.

## SAIL SERIES

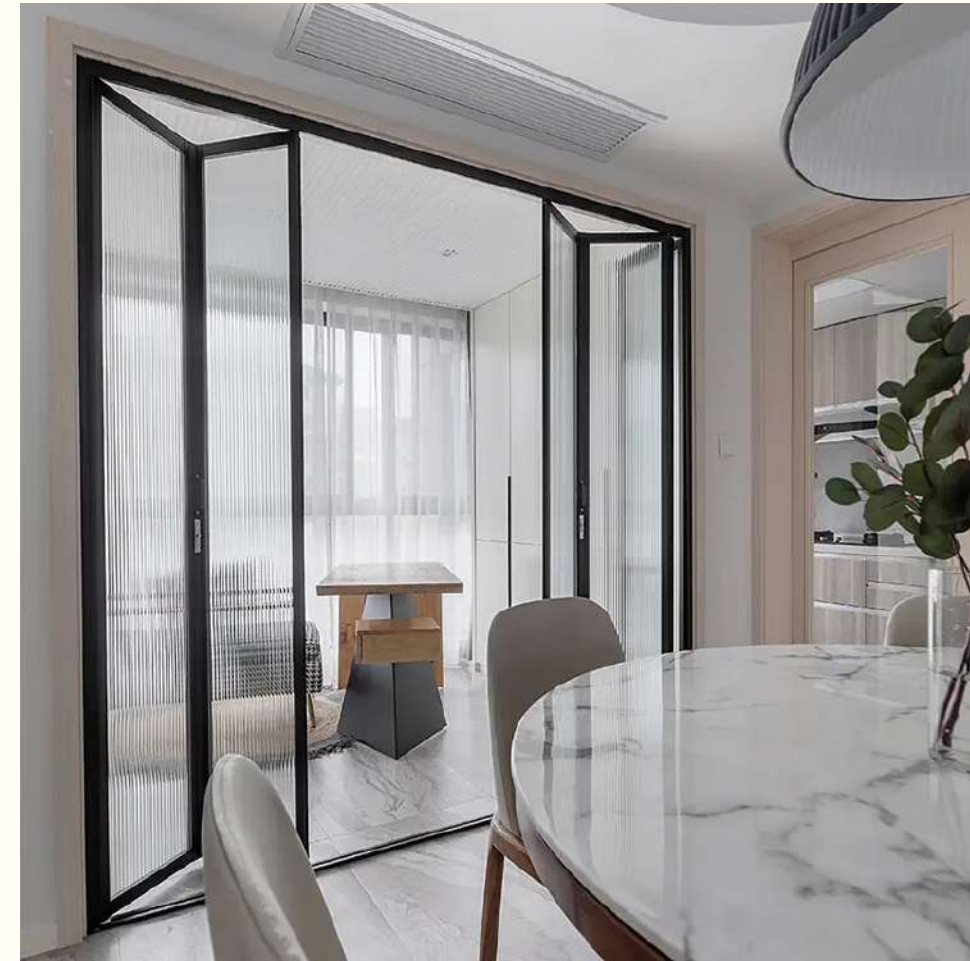

### SLIDING FOLDING PARTITION

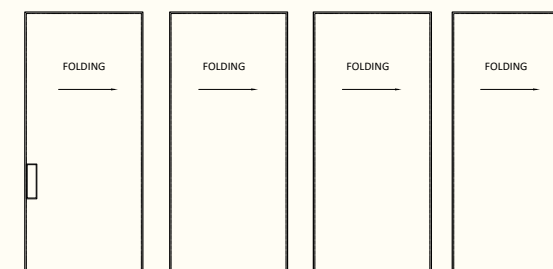
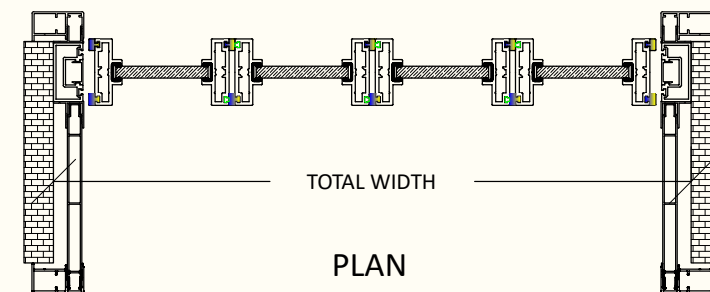

ELEVATION

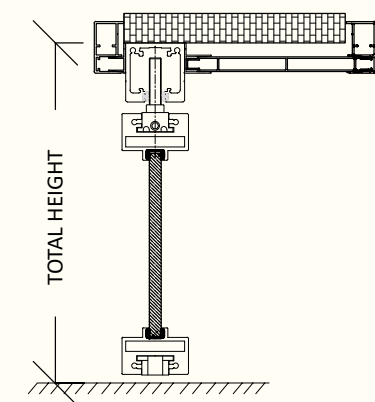

SIDE ELEVATION





## TWIRL SERIES

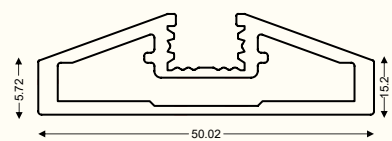

**SCP - 311**  
Side Profile  
Size : 3 mtr.  
Finish : Black Matt

Twirl Series Partition is a panel with a vertical pivoting revolving movement, with adjustable pivot hinges, which lends itself to numerous design solutions. The door with 360° revolving always has a bidirectional opening and is available with a central or offset Porta pivot. By placing two or more panels side by side, you can configure partially or totally openable partitions.

## TWIRL SERIES



## PORTA 360 SERIES

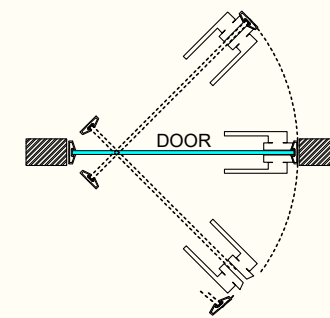

PLAN

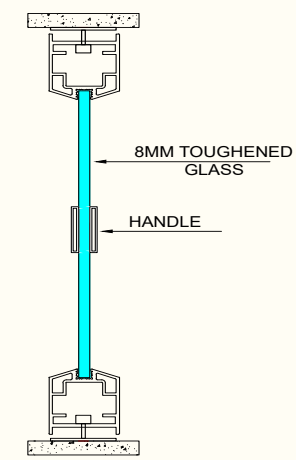

SIDE ELEVATION

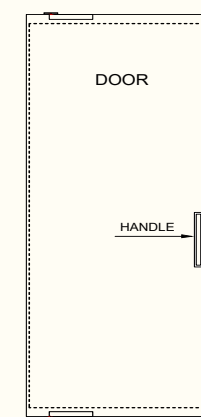

FRONT ELEVATION





## DRIZZLE SERIES

45mm x 18mm  
5mm/8mm Glass

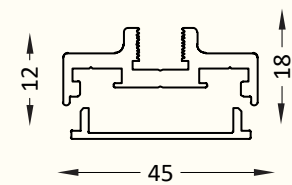

**SCP - 251 + 252**  
Door Profile  
Size : 5.8 mtr  
Finish : Black matt, Gold Brush

Elevate your bathroom decor with the Drizzle Series Shower Enclosure, a combination of elegance and practicality. This stylish shower enclosure is designed to provide a luxurious showering experience while ensuring durability and easy maintenance. It is adorned with aluminum profiles that provide not only an aesthetic appeal but also a sleek and modern appearance. Aluminum is an exceptionally durable material capable of withstanding the moist and humid conditions of a shower, ensuring the long-term structural integrity and endurance of the enclosure.

## DRIZZLE SERIES



### L FRAME DRIZZLE PARTITION

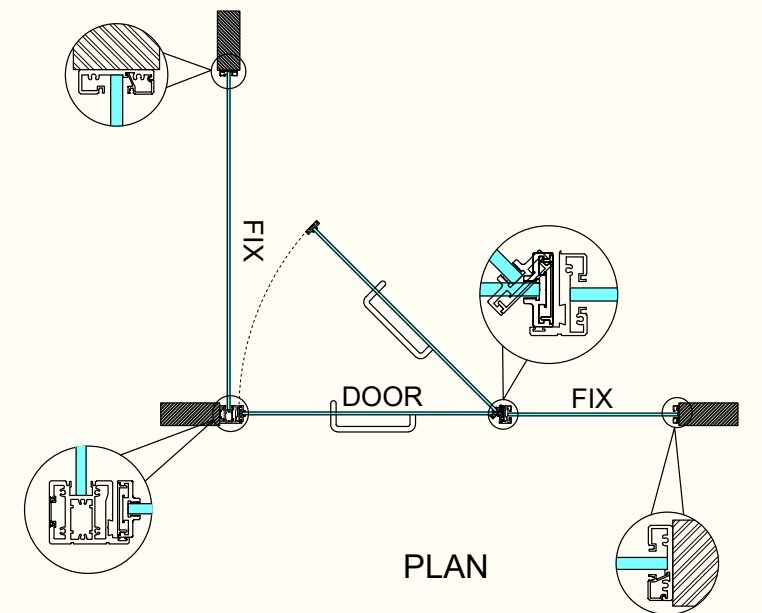

### 135° ANGLE DRIZZLE PARTITION

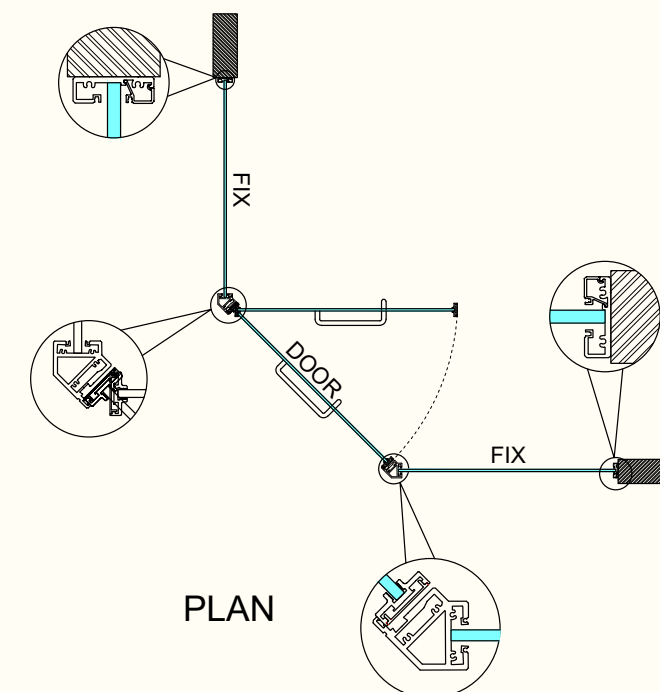



**DRIZZLE SERIES**



**T FRAME DRIZZLE PARTITION**

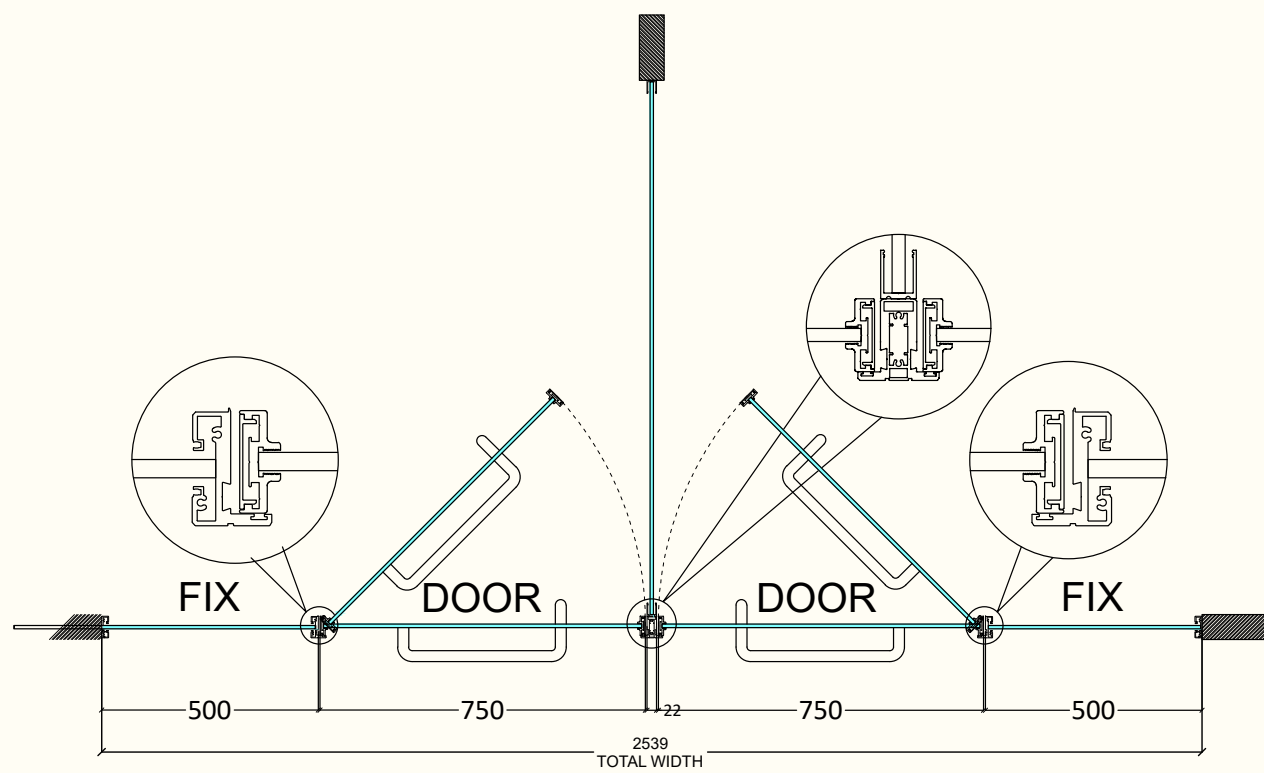

**AURA SERIES**

40mm x 12mm  
5mm/8mm Glass

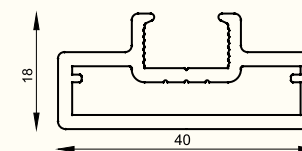

SCP - 211  
Frame Profile  
Size : 5.8 mtr.  
Finish : Black Matt, Gold Brush

Aura Series is a contemporary door in terms of concept, use of materials and technologies, but classic when it comes to aesthetics. It creates perfect and customized solutions that define residential and professional spaces. Aura Series has cultivated an international reputation by focussing on the creation of its sleek, essential designs.



**AURA SERIES**



**OPENABLE DOOR WITH FRAME**

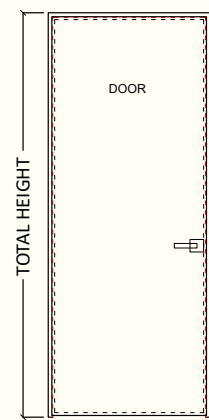
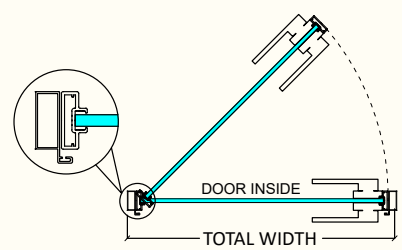

ELEVATION

**FIX PARTITION WITH OPENABLE DOOR**

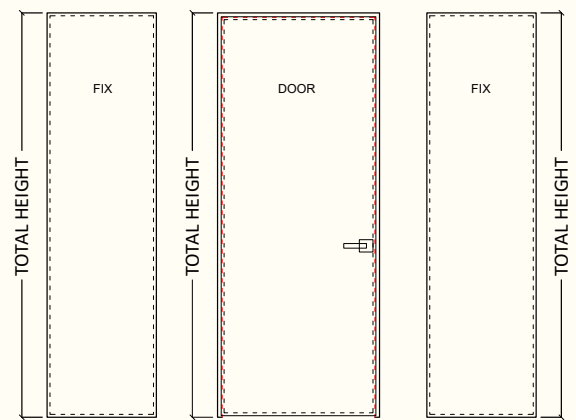
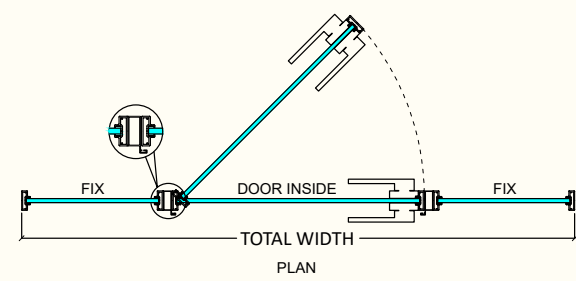

ELEVATION

**AURA SERIES**



**SYNCHRONIZE SLIDING SYSTEM**

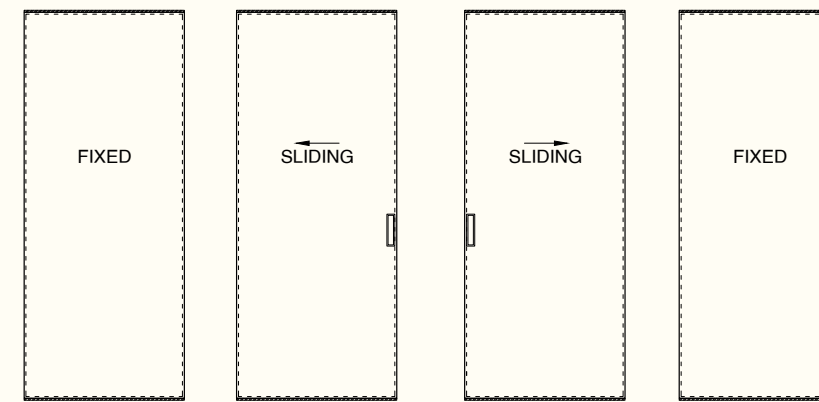
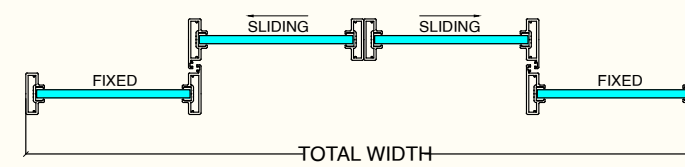

FRONT ELEVATION

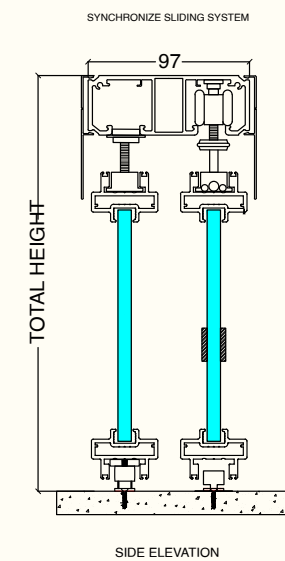

SIDE ELEVATION

**AURA SERIES**

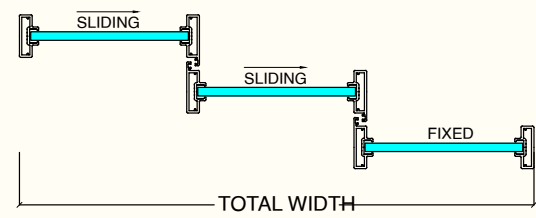

PLAN

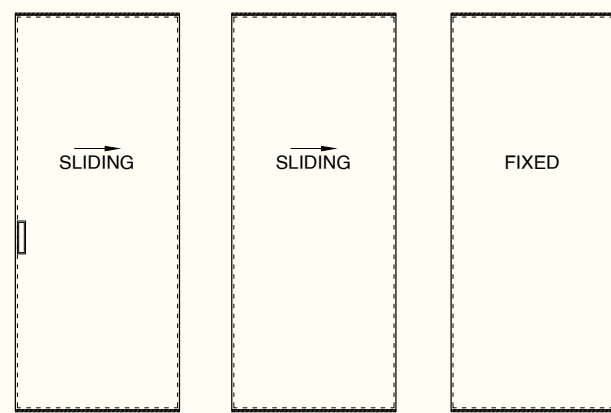

FRONT ELEVATION

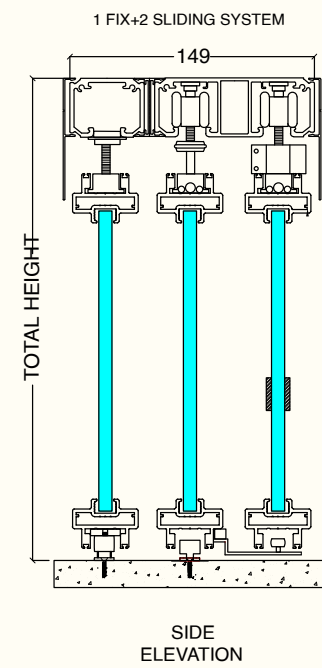

SIDE ELEVATION

**AURA SERIES**



**1FIX + 1 SLIDING SYSTEM**

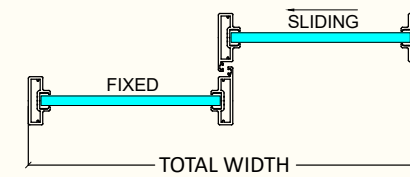

PLAN

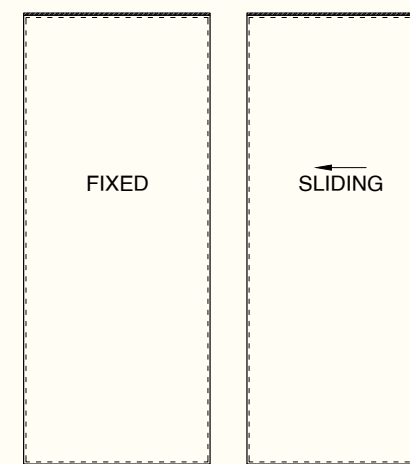

FRONT ELEVATION

1FIX+1SLIDING SYSTEM

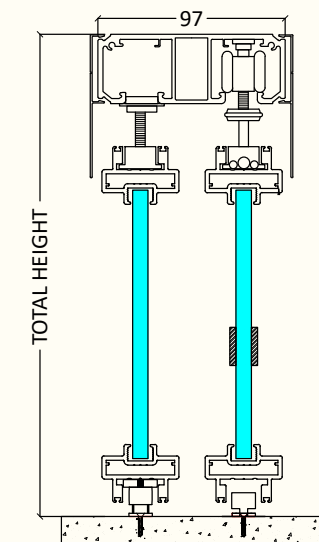

SIDE ELEVATION





# LINVISIBLE SERIES

40mm x 5mm  
5mm/8mm Glass

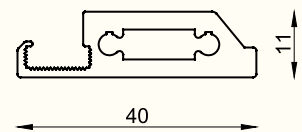

**SCP - 231**  
Frame Profile  
**Size** : 5.8 mtr.  
**Finish** : Black Matt, Champagne Gold

Evolution of the Linvisible Series enhances the surrounding space thanks to the graphic design given by the aluminum strips of 5mm visibility that make up the frame. It is an ethereal and elegant design door with the ability to define residential settings and workspaces and make them communicate with each other. Configurable in different systems made of Sliding, Swings and Fixed panels, it is a highly versatile interior door that is contemporary in terms of design and materials but classic in terms of aesthetics.

## LINVISIBLE SERIES



### OPENABLE DOOR WITH FRAME

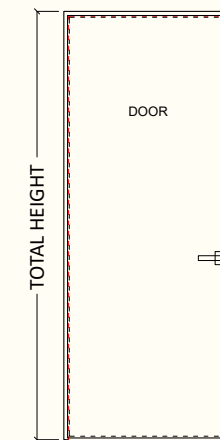
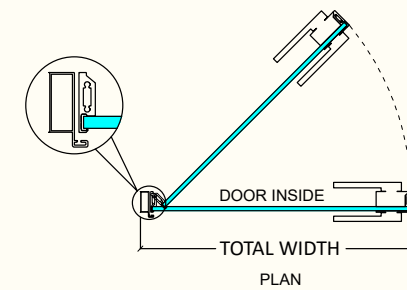

ELEVATION

### FIX PARTITION WITH OPENABLE DOOR

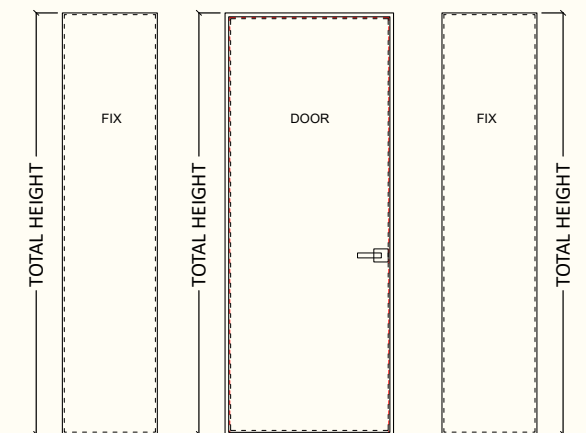
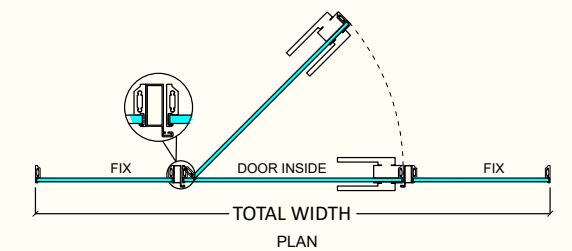

ELEVATION

LINVISIBLE SERIES



SYNCHRONIZE SLIDING SYSTEM

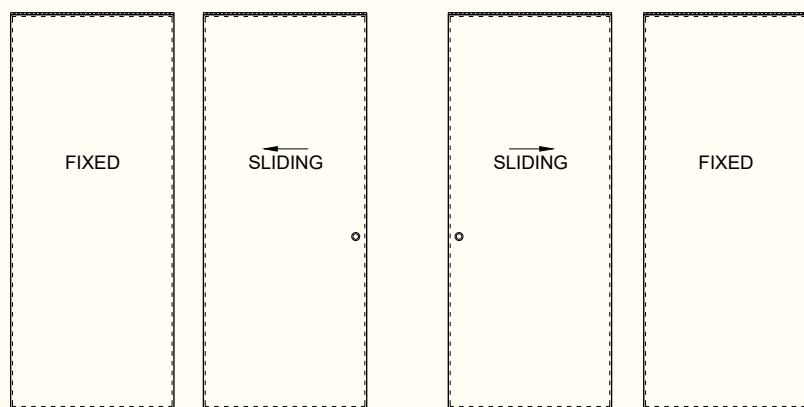
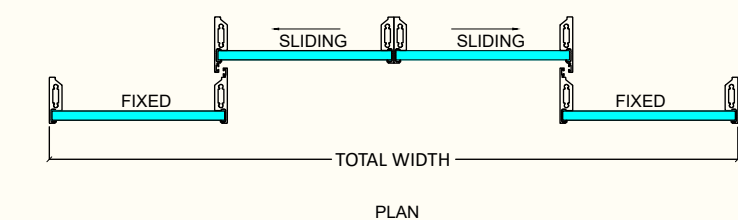

FRONT ELEVATION

SYNCHRONIZE SLIDING SYSTEM

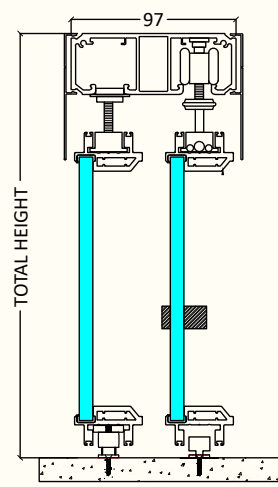

SIDE ELEVATION

LINVISIBLE SERIES



TELESCOPIC SLIDING SYSTEM (1FIX + 3 SLIDING)

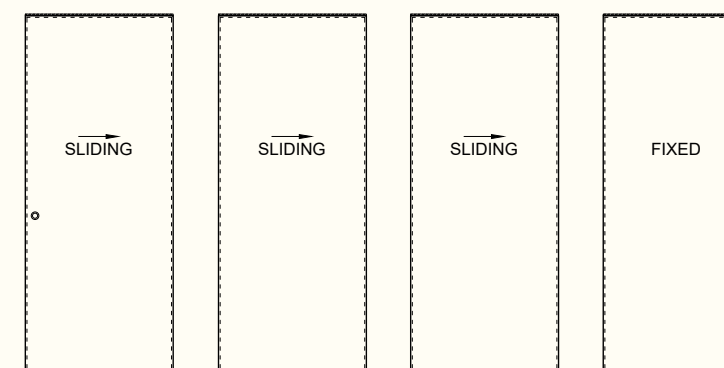
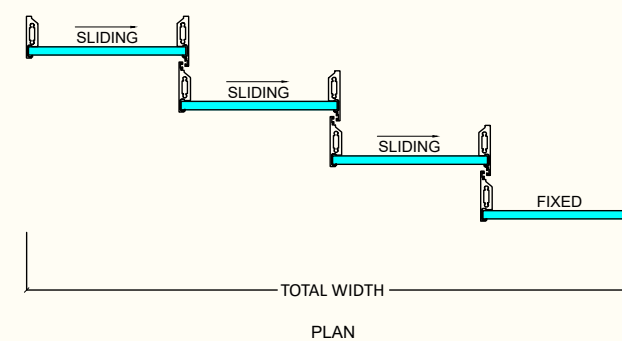

FRONT ELEVATION

1 FIX+3 SLIDING SYSTEM

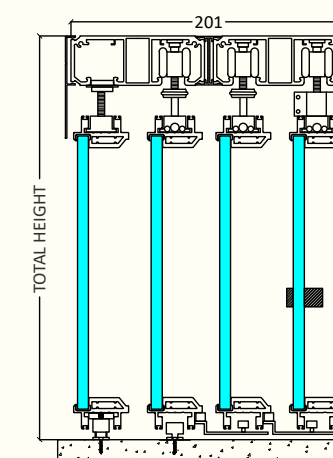

SIDE ELEVATION



**LINVISIBLE SERIES**



**1FIX + 1 SLIDING SYSTEM**

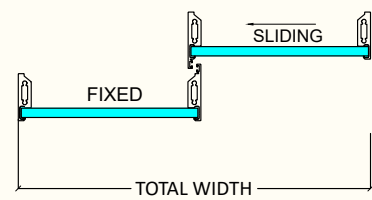

PLAN

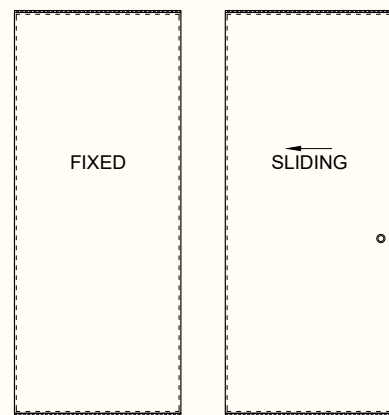

FRONT ELEVATION

1FIX+1SLIDING SYSTEM

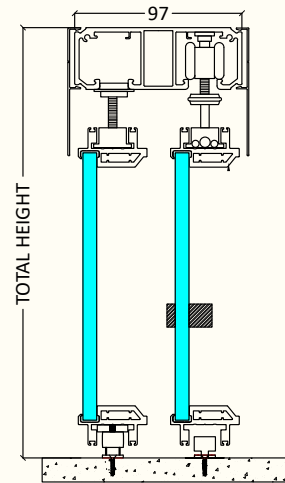

SIDE ELEVATION

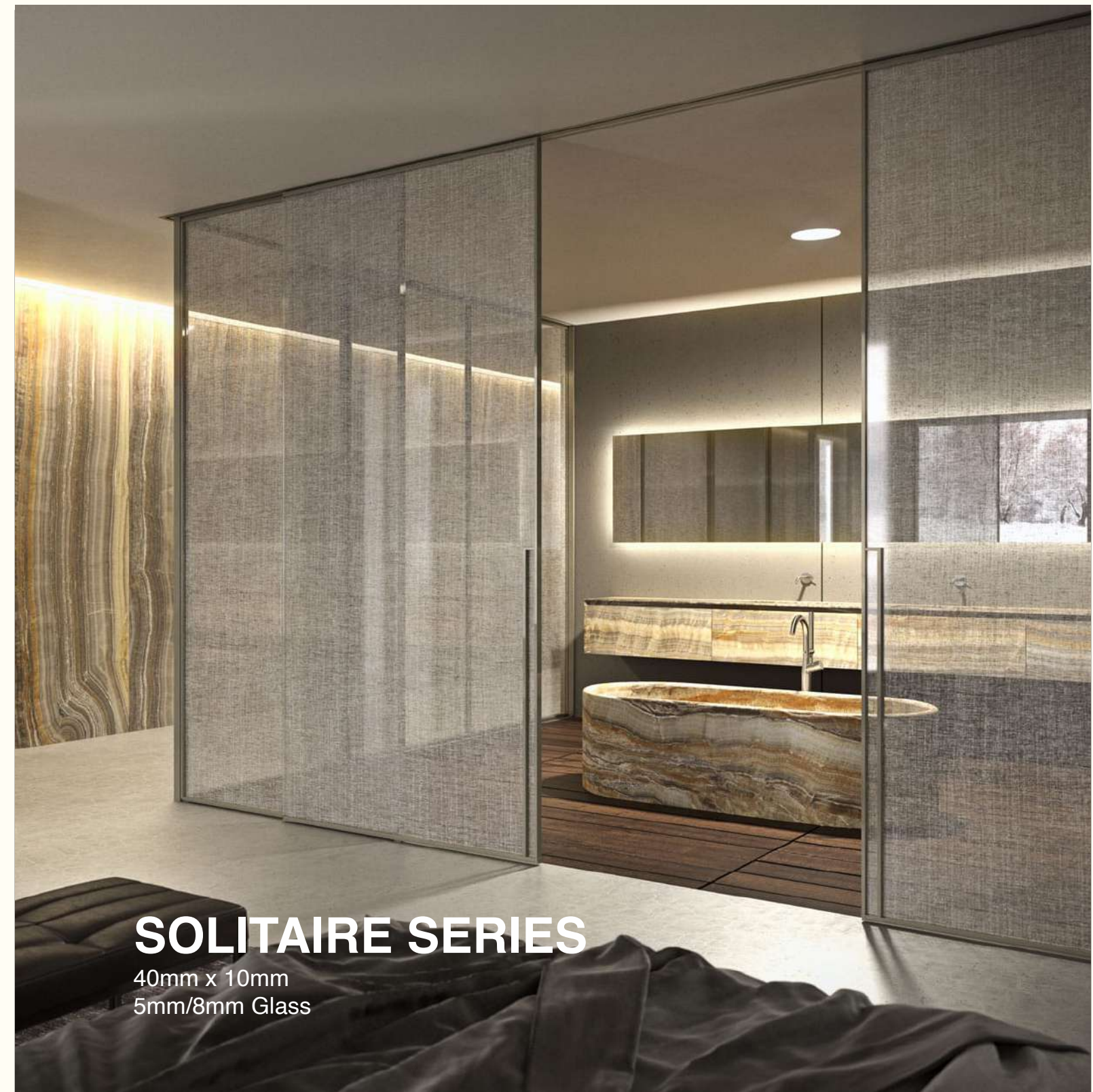

**SOLITAIRE SERIES**

40mm x 10mm  
5mm/8mm Glass

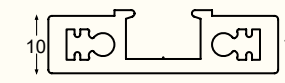

**SCP - 181**  
40mm x 10mm Frame Profile  
Size : 5.8 mtr.  
Finish : Antique Brush, Black Matt, Champagne Gold

The coplanar Solitaire Series is another solution of the Signature collection for the projects, aiming at integrating as much as possible the elements in an overall coherent and stylistically defined vision. The customized door at full height, together with the completely sleekest solution for the interior design.



**SOLITAIRE SERIES**



**OPENABLE DOOR WITH FRAME**

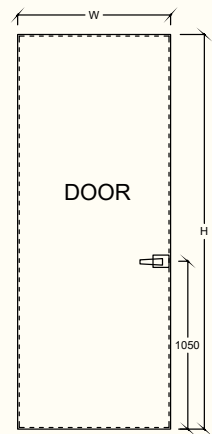
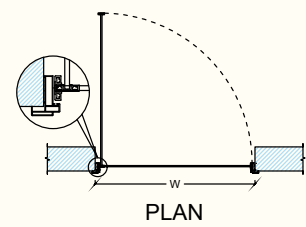

**ELEVATION**

**FIX PARTITION WITH OPENABLE DOOR**

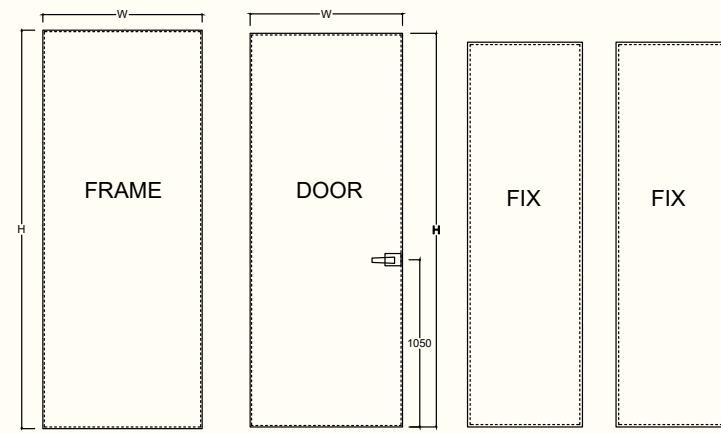
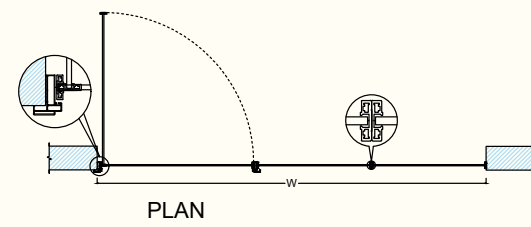

**ELEVATION**

**SOLITAIRE SERIES**



**SYNCHRO SLIDING SYSTEM**

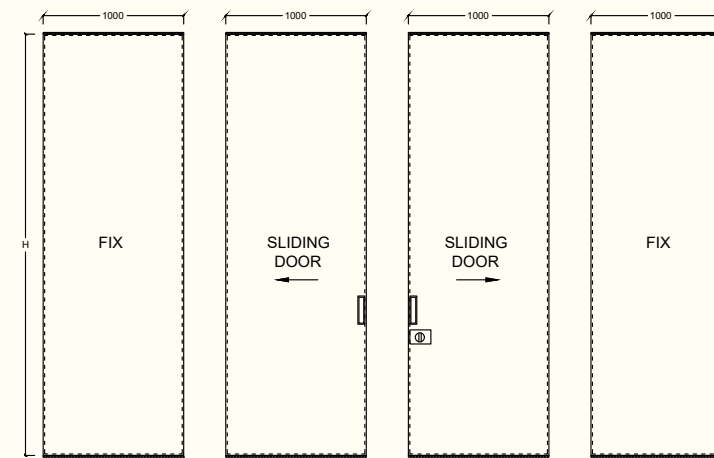
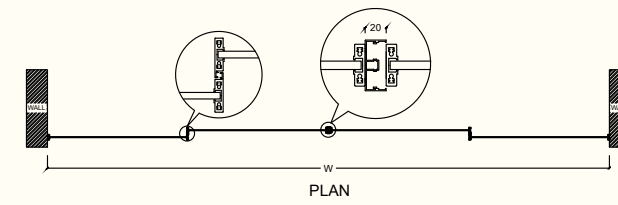

**ELEVATION**

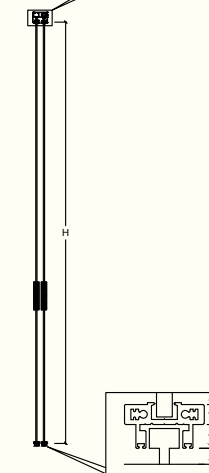
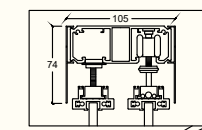



**SOLITAIRE SERIES**



**SLIDING TELESCOPIC SYSTEM**  
(1 FIX + 3 SLIDING / 1 FIX + 2 SLIDING / 2 DOOR SLIDING)

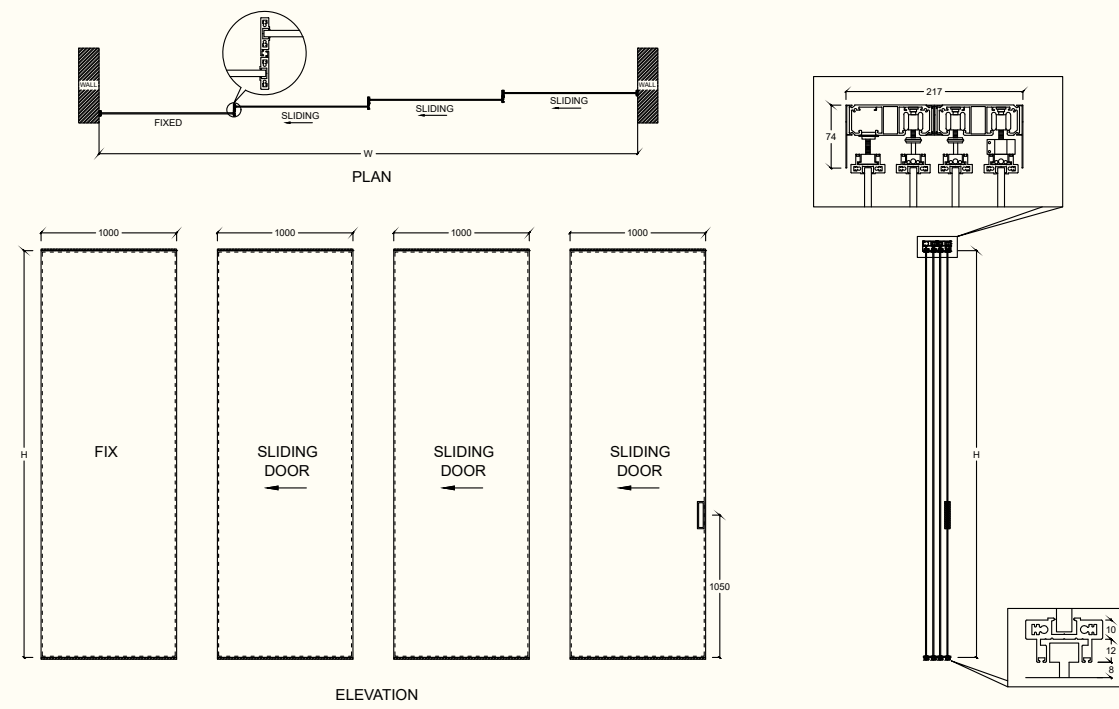

**SOLITAIRE SERIES**



**1 FIX + 1 SLIDING SYSTEM**

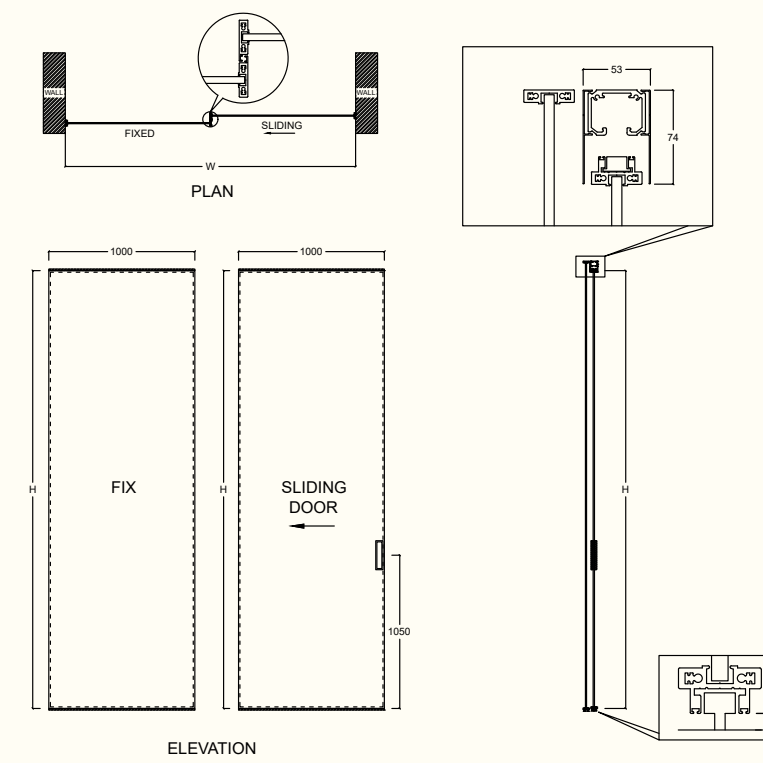





# DOUBLE GLAZE SERIES

25mm DGU Glass

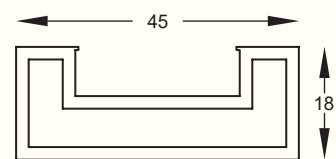

**SCP - 161**  
 Frame Profile  
 Size : 5.8 mtr.  
 Finish : Black Matt

The interpretation of DGU Glass door with maximum simplicity. The doors are made with a structural aluminium profile with a maximum glass thickness available in black finish, which allows to spread the best of the aesthetical potential of the DGU glasses. Transparency, opacity and reflections, create an exclusive collection which allows an incredible selection of stylistic solutions.

## DOUBLE GLAZE SERIES



### OPENABLE DOOR

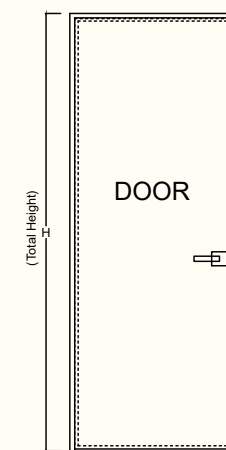
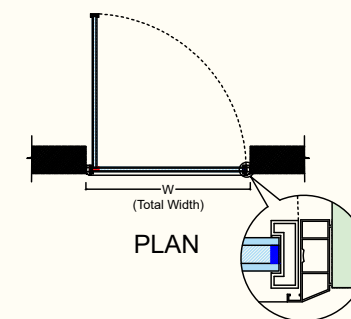

### ELEVATION



## DOUBLE GLAZE SERIES



### 1FIX + 1 SLIDING SYSTEM

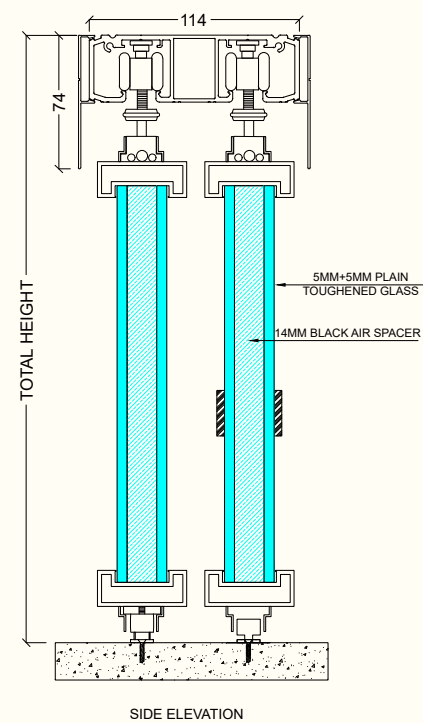
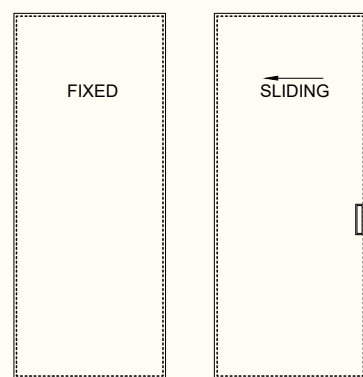
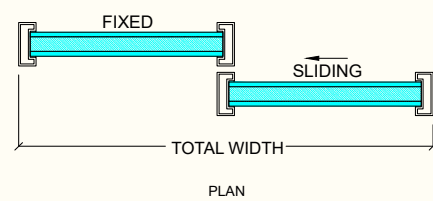

36



## INCLINE SERIES

45mm (Cross Section)  
5mm/8mm Glass

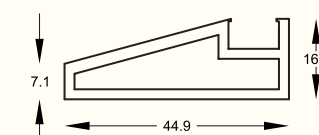

**SCP - 151**  
Slant Frame Profile  
Size : 5.8 mtr.  
Finish : Champagne Gold

Incline Series is inspired to the modern partition systems, that clearly reflects the aesthetic and functional qualities, as well as graphic and architectural features. An ancient solution, has been replaced through the cross vertical aluminum profile used for Fixed / Openable as well as Sliding systems becomes an interesting opportunity to characterize the space.

37



**INCLINE SERIES**



**OPENABLE DOOR WITH FRAME**

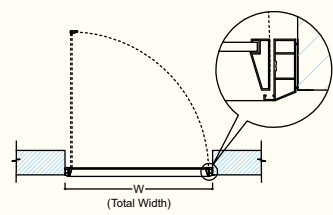

PLAN

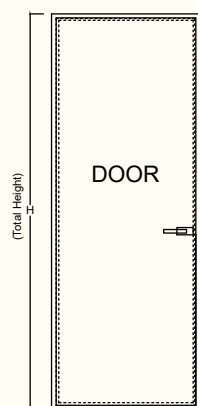

ELEVATION

**FIX PARTITION WITH OPENABLE DOOR**

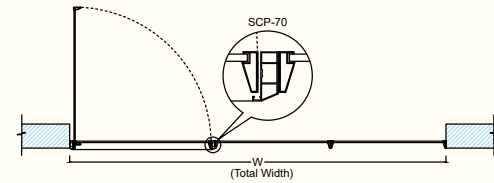

PLAN

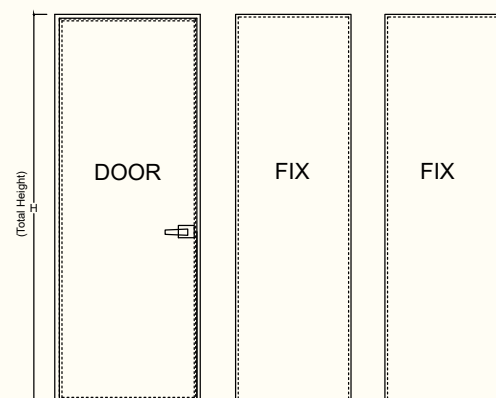

ELEVATION

**INCLINE SERIES**



**SYNCHRO SLIDING SYSTEM**

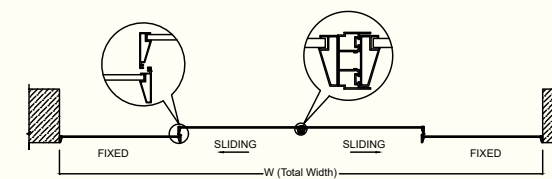

PLAN

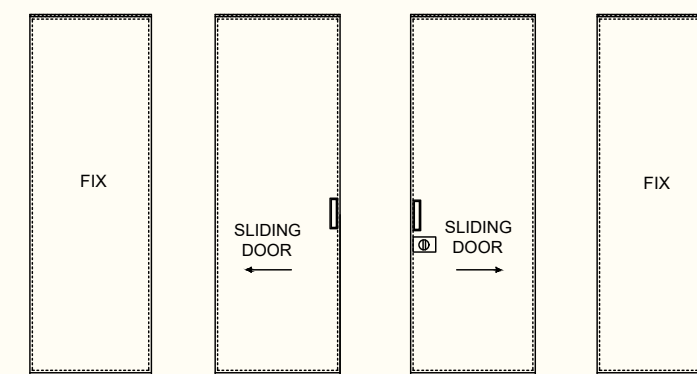
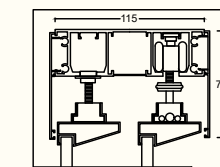

ELEVATION



**INCLINE SERIES**



**SLIDING TELESCOPIC SYSTEM**  
(1 FIX + 3 SLIDING / 1 FIX + 2 SLIDING / 2 DOOR SLIDING)

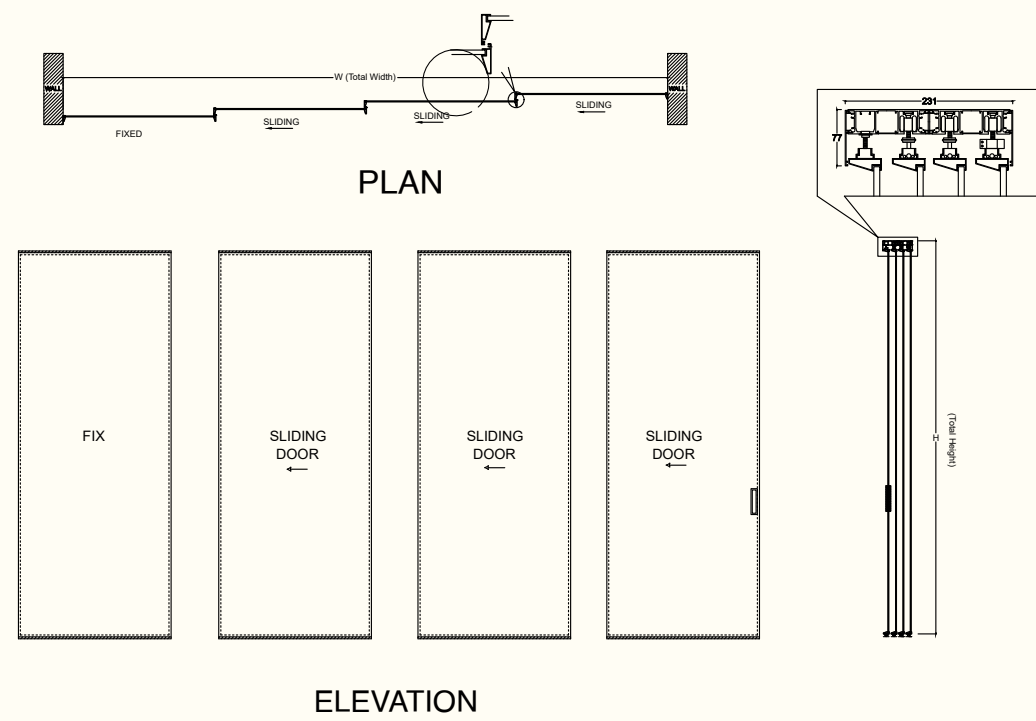

**INCLINE SERIES**



**1 FIX + 1 SLIDING SYSTEM**

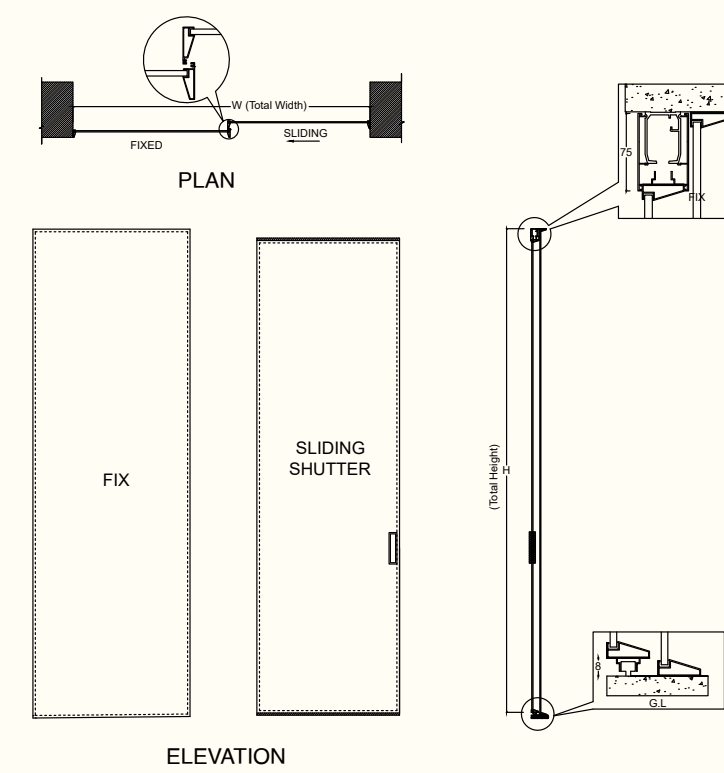





# SLEEK SERIES

45mm x 7mm  
5mm/8mm Glass

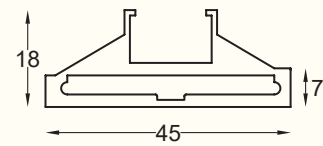

**SCP - 67**  
7mm Frame Profile  
Size : 5.8 mtr.  
Finish : Black Matt, Champagne Gold, Gold Brush

The sleek system is used to solve the restriction of traditional indoor sliding door ground rail, Completely release the space on the ground, making the space separate and continuous, The real integration of home space is perfect, At the same time, it also helps to make the home life smooth and clean.

## SLEEK SERIES



### OPENABLE DOOR WITH FRAME

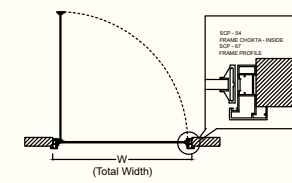

PLAN

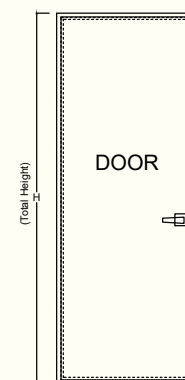

ELEVATION

### FIX PARTITION WITH OPENABLE DOOR

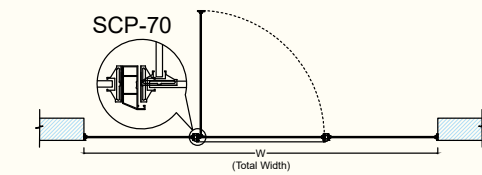

PLAN

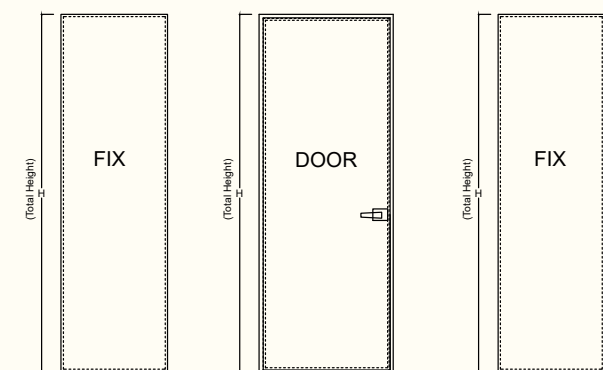

ELEVATION



**SLEEK SERIES**

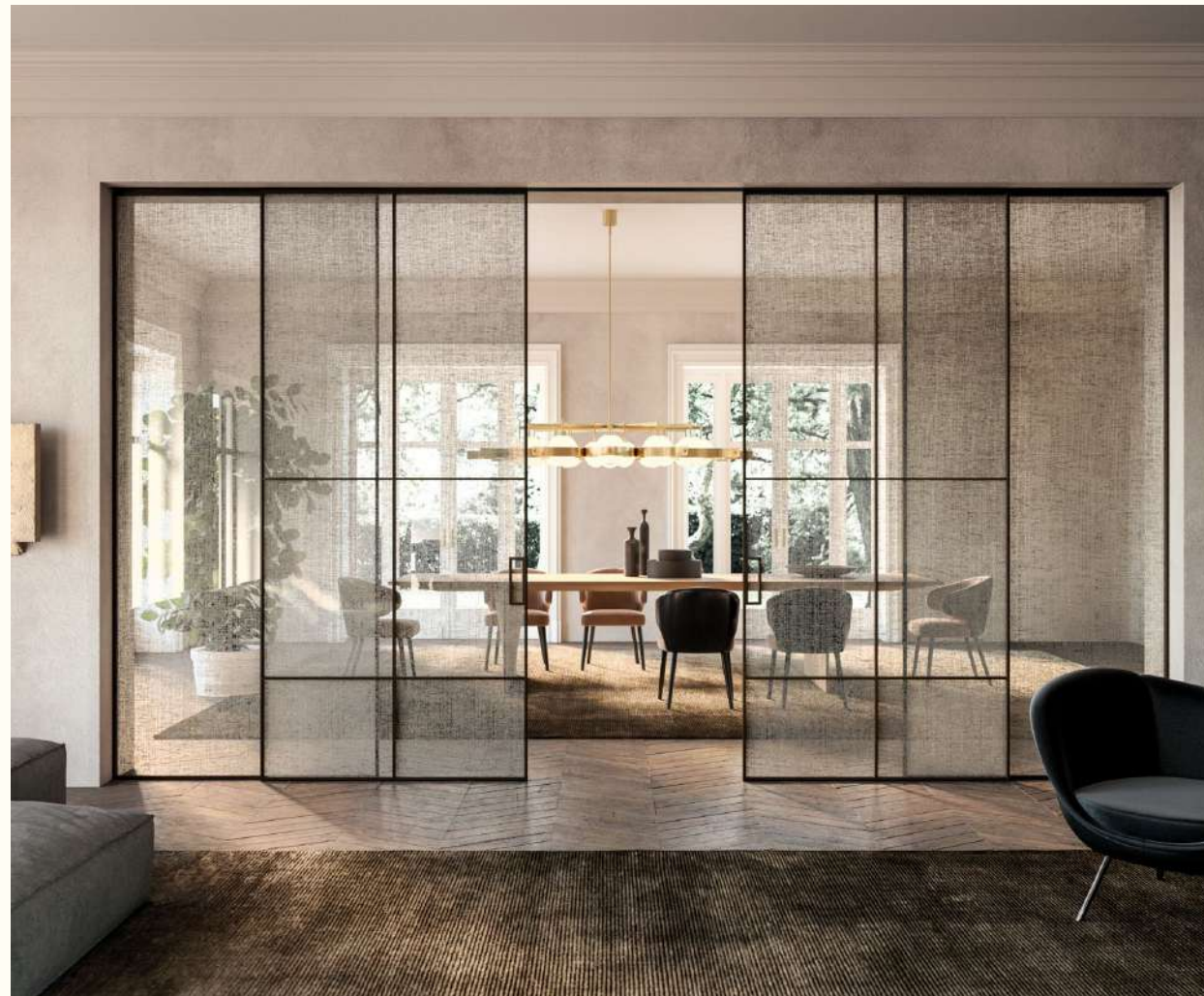

**SYNCHRO SLIDING SYSTEM**

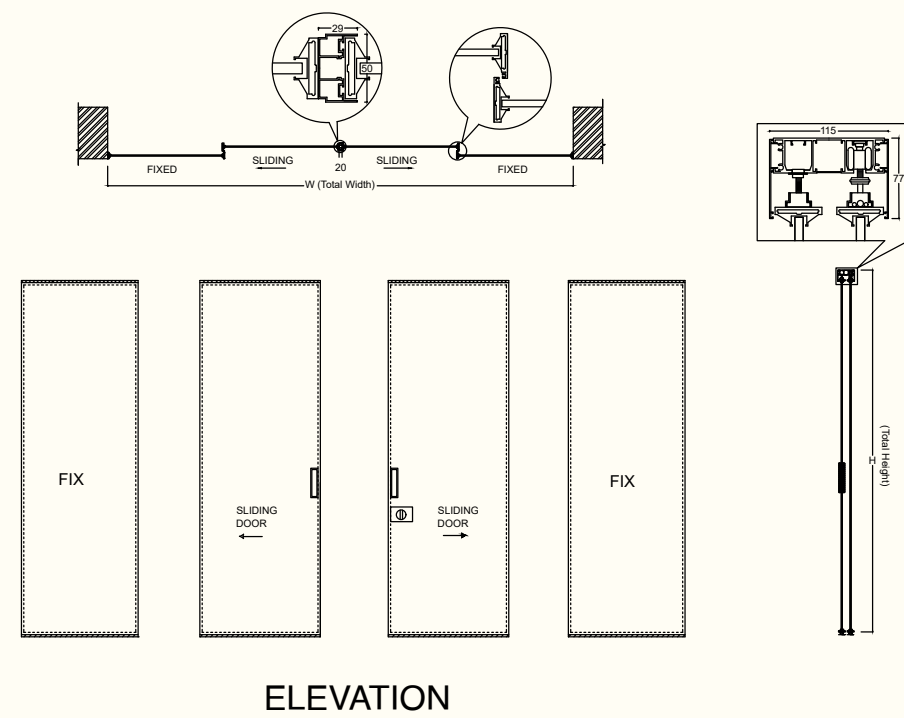

**SLEEK SERIES**



**SLIDING TELESCOPIC SYSTEM**  
(1 FIX + 3 SLIDING / 1 FIX + 2 SLIDING / 2 DOOR SLIDING)

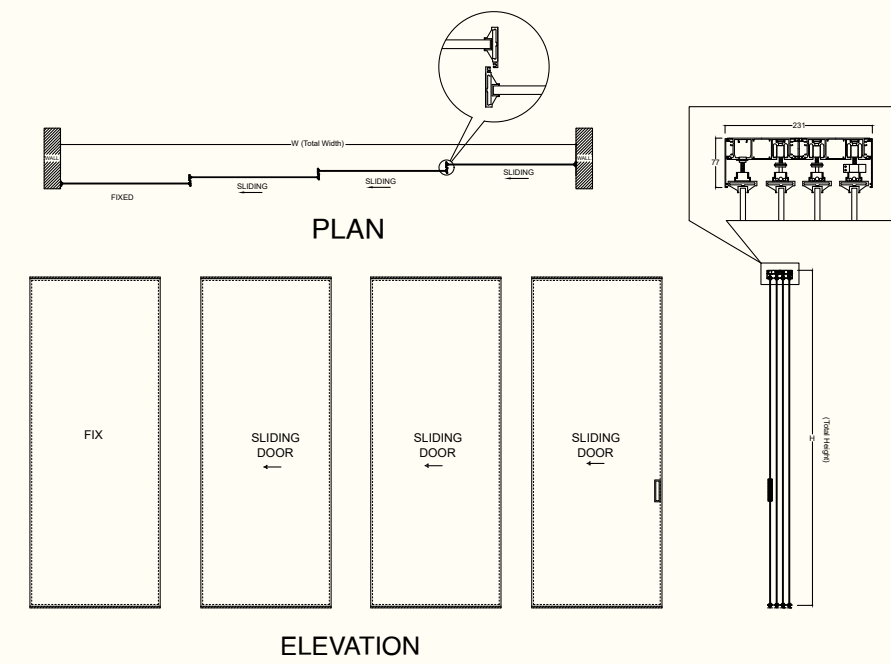



**SLEEK SERIES**



**1 FIX + 1 SLIDING SYSTEM**

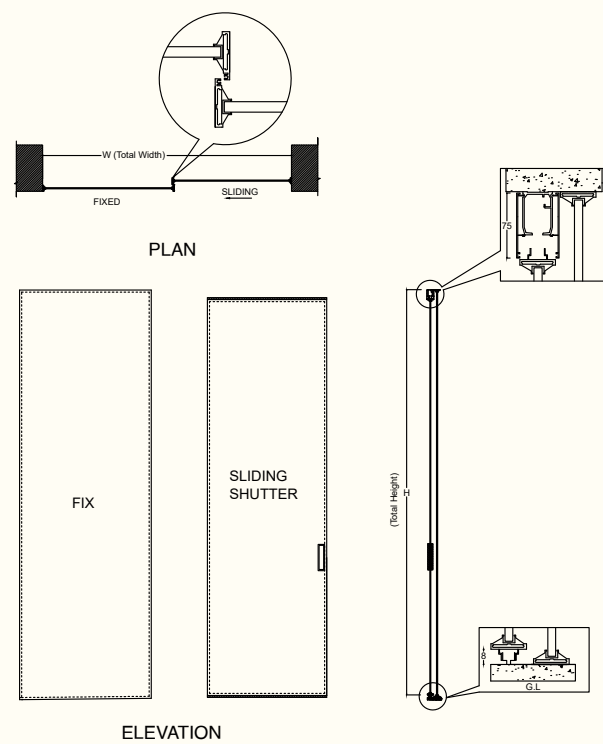

**VERTEX SERIES**

45mm x 16mm  
5mm/8mm Glass

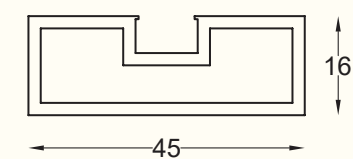

**SCP - 51**  
Frame Profile  
Size : 5.8 mtr.  
Finish : Black Matt, Gold Brush

The pleasure of the soul is not the external absorption, but the inner simplicity. Space design, is to explore the heart, but also the expression of emotional creativity place. Design language with concise abstemious, remove a space redundant act the role of, let a space pass Give us a new way of life. Let pleasure drive creativity.



**VERTEX SERIES**



**OPENABLE DOOR WITH FRAME**

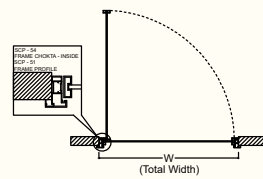

PLAN

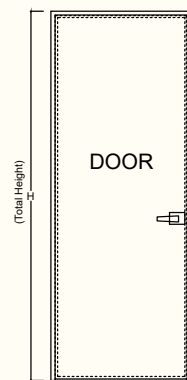

ELEVATION

**FIX PARTITION WITH OPENABLE DOOR**

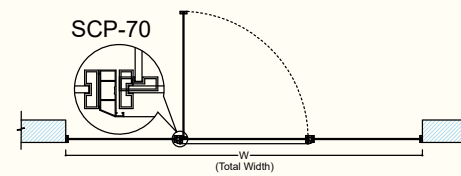

PLAN

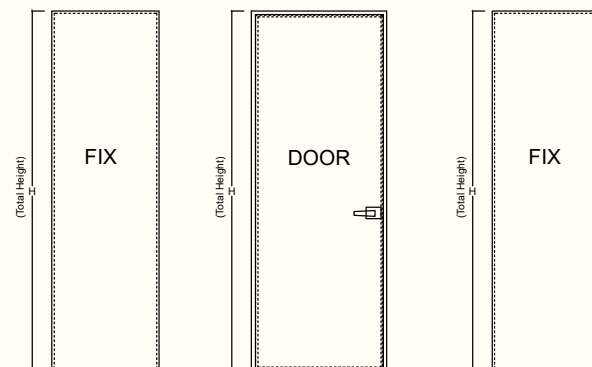

ELEVATION

**VERTEX SERIES**



**SYNCHRO SLIDING SYSTEM**

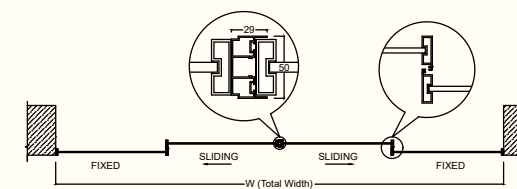

PLAN

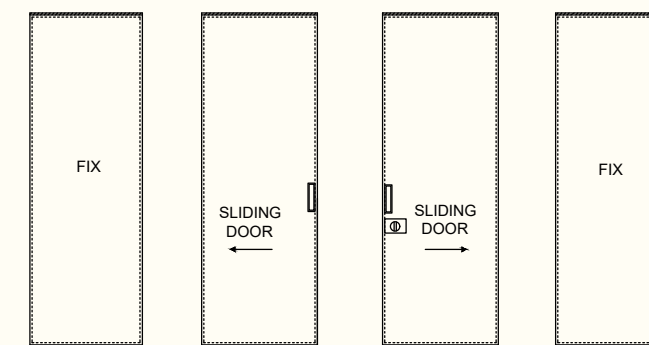

ELEVATION

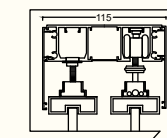

(Total Height)

VERTEX SERIES

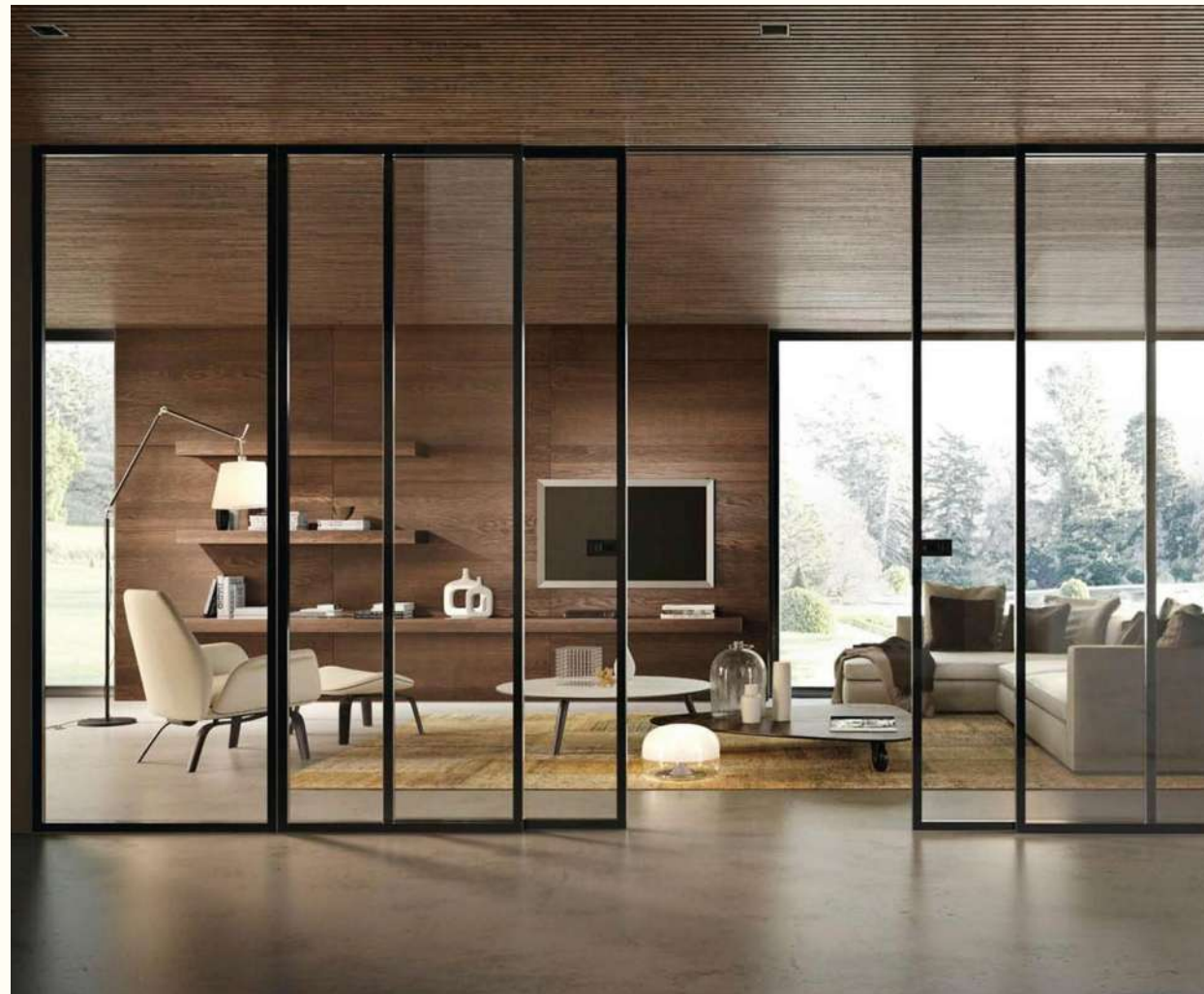

SLIDING TELESCOPIC SYSTEM  
(1 FIX + 3 SLIDING / 1 FIX + 2 SLIDING / 2 DOOR SLIDING)

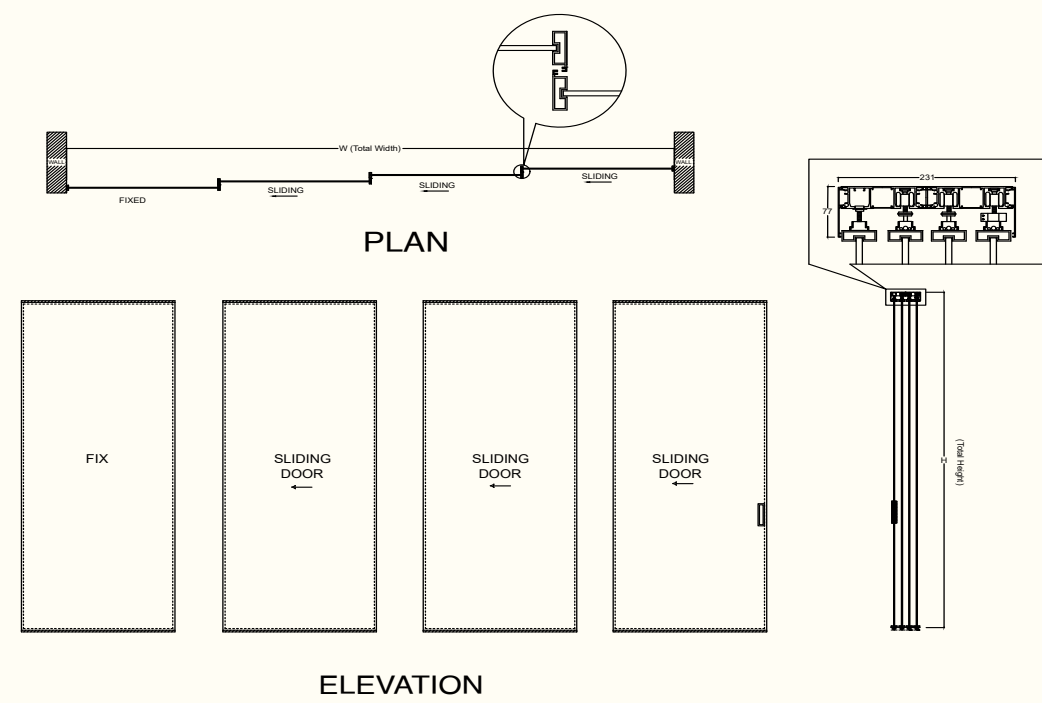

VERTEX SERIES



1 FIX + 1 SLIDING SYSTEM

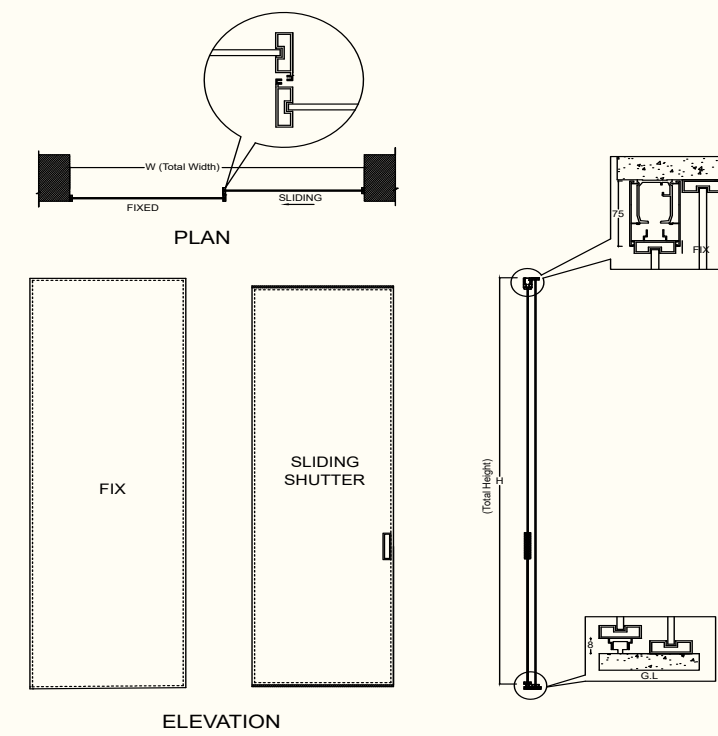





# PRIMA SERIES

5mm Any Finished Product  
(Glass/Laminate/Veneer)

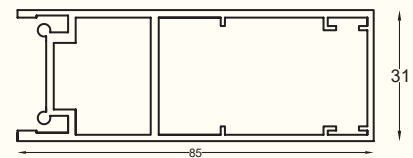

**SCP - 131**  
Door Frame Profile  
Size : 3 mtr.  
Finish : Aluminium

The coplanar Prima swing door, with lacquered glass or leather jamb, is another solution of the Signature collection for the projects, aiming at integrating as much as possible the elements in an overall coherent and stylistically defined vision. The customized door at full height, together with the panel totally flush to the wall, allows Prima to suggest new solutions for the interior design.

## PRIMA SERIES



### OPENABLE DOOR

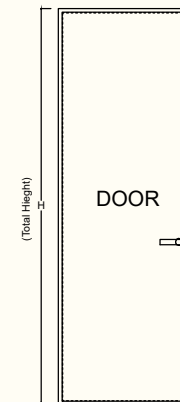
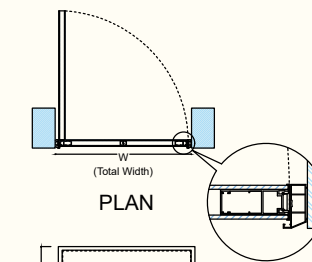



# GLAZE SPACE SERIES

5mm Glass

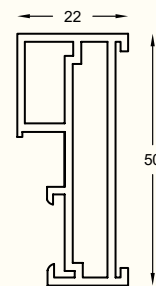

**SCP - 141**  
 Partition Frame Profile  
 Size : 5.8 mtr.  
 Finish : Black Matt

Lightness, transparency, ability to split and join at the same time. The references to the far East are clearly visible in Glaze Space, which refers to the typical partitions of the movable walls and the furnishings that identify the traditional Japanese house. An ethereal diaphragm, with delicate ribs which settle up the geometry of the frame reproduced in a contemporary and current context from the combination

## GLAZE SPACE SERIES



### FIX PARTITION

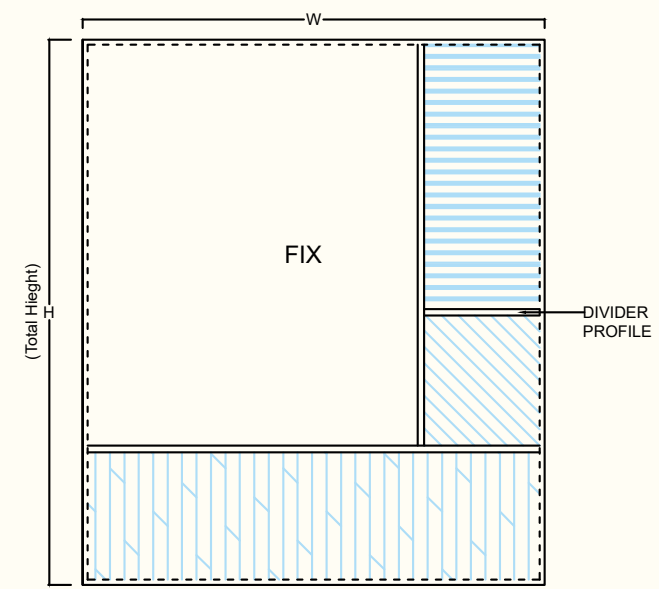

ELEVATION

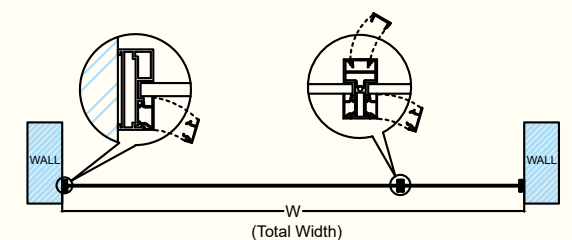

PLAN





**GRANDO COMFO  
SERIES  
(POLE SYSTEM)**

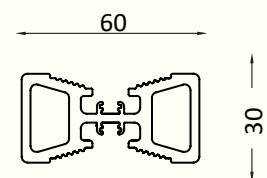

**SCP - 301**  
Column Profile  
Size : 3 mtr.  
Finish : Black Matt

Grando Comfo Series is a new conception of the living room system on personalised basis. The design consists of a back panel Aluminium Profile, a pure surface with Hanging Drawers, cloth rack pipe holders, LED Glass Shelf, Hanging Wardrobe Accessories which holds storage units made entirely of glass including drawers in short giving a complete range to give a Perfect Modular Walking Wardrobe Concept.

**GRANDO COMFO SERIES**







**GRANDO COMFO  
SERIES  
(BACK PANEL HANGING SYSTEM)**

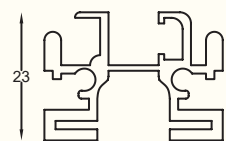

**SCP - 111**  
Wall Panel Profile  
Size : 2.8 mtr.  
Finish : Aluminium Matt

Grando Comfo Series is a new conception of the living room system on personalised basis. The design consists of a back panel Aluminium Profile, a pure surface with Hanging Drawers, cloth rack pipe holders, LED Glass Shelf, Hanging Wardrobe Accessories which holds storage units made entirely of glass including drawers in short giving a complete range to give a Perfect Modular Walking Wardrobe Concept.

**GRANDO COMFO SERIES**







KOIL Hardware Pvt. Ltd.

03/A, Ground Floor, Pinnacle Business Park  
Corporate Road, Prahladnagar, Ahmedabad 380015

Email: [info@koilindia.com](mailto:info@koilindia.com)