

Hardware Collection  
**Product Catalogue**

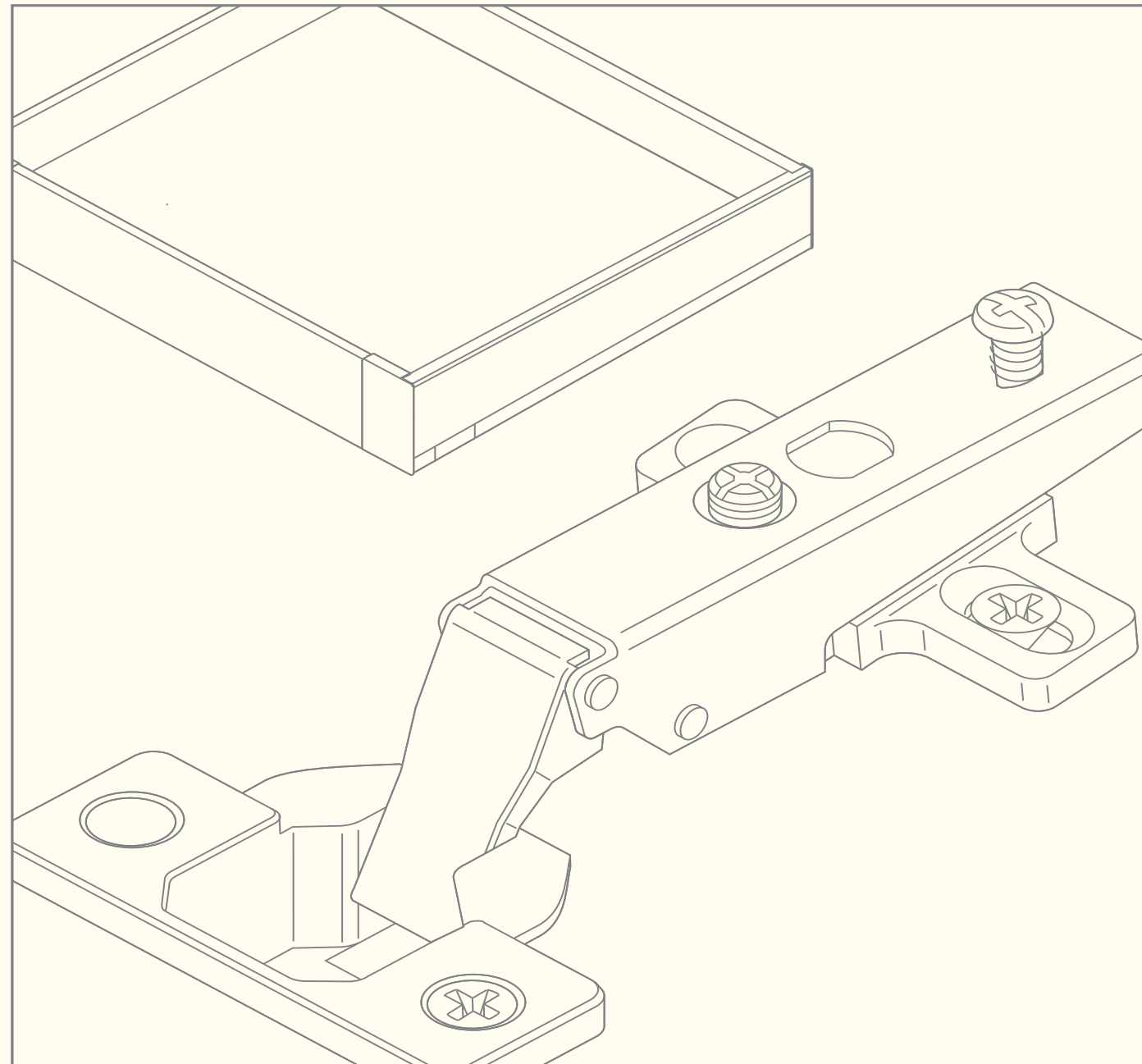

**THE ART  
WE OWN**





This is our culture.  
This is us.

## About Us

For over 13 years, KOIL has been leading the field of Aluminium & Hardware with constant improvement, groundbreaking innovation, and the latest technology.

Renowned for our commitment to exponential growth, we are the preferred end-to-end solution provider for architects and interior designers across India. Our devoted & passionate team blends creativity with technological expertise seamlessly to deliver unparalleled design solutions.

In recent years, we have expanded into complete glass solutions, offering unmatched quality and precision by our proficient team.

Our aim lies in pushing boundaries by developing ingenious, aesthetically exclusive ideas while ensuring maximum reliability for our clients.

## Why Choose Us?

Unmatched Quality

Market Leadership

Pioneering Innovation

Cutting-Edge Technology

Finesse in every Detail

Highly Skilled Team

Exceeding Customer Expectations



**ALUMINUM PROFILES, SLIDING SYSTEM & HARDWARE**

**09**

Drawer  
System

**11**

Kitchen Drawer  
Accessories

**12**

Kitchen  
Accessories

**13**

Premium Wardrobe  
Accessories

**14**

Sliding  
System

**19**

Aluminium  
Profiles

**24**

Aluminium  
Handles

**27**

Auto  
Hinge

**28**

Drawer  
Channel & Door  
Straightener

**29**

Gas Spring & Bed  
Pro Lift Fitting

**30**

Cabinet  
Support

**31**

Alu. Ventilation  
Grill

Index

*Hardware Collection*

Unlocking the Power of Precision:  
Where Innovation Meets Quality



**DRAWER SYSTEM & KITCHEN / WARDROBE ACCESSORIES**

KOIL Hardware Drawer System, Kitchen and Wardrobe Accessories are about being there for life. It is designed to feel everyone special in everyday life. We always emphasize upon simple but brilliant designs.

**DRAWER SYSTEM**

**SLIM BOX DRAWER**

- Height :
  - KSBD - 01 - 84mm
  - KSBD - 02 - 116mm
  - KSBD - 03 - 167mm
  - KSBD - 04 - 199mm
- Depth :
  - 300mm, 350mm, 400mm, 450mm, 500mm, 550mm
- Weight Capacity : 40 kg.
- Colour : Iron Grey/White



**SLIM BOX DRAWER WITH CONNECTOR**

**INNER SLIM BOX DRAWER**

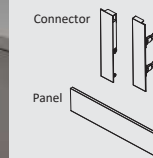

- KSBD - 01 SLIM BOX DRAWER
- KSBA - 01 CONNECTOR
- KSBA - 02 PUMPING PANEL

**SLIM BOX DRAWER WITH HALF GLASS**

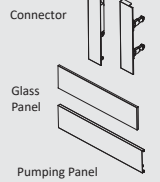

- KSBD - 03 SLIM BOX DRAWER
- KSBA - 05 CONNECTOR
- KSBA - 07 GLASS PANEL
- KSBA - 06 PUMPING PANEL

**SLIM BOX DRAWER WITH SQUARE RAILING**

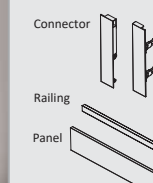

- KSBD - 03 SLIM BOX DRAWER
- KSBA - 03 CONNECTOR
- KSBA - 04 RAILING
- KSBA - 02 PUMPING PANEL

**SLIM BOX DRAWER WITH FULL GLASS**

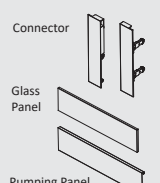

- KSBD - 03 SLIM BOX DRAWER
- KSBA - 08 CONNECTOR
- KSBA - 09 GLASS PANEL
- KSBA - 06 PUMPING PANEL

## DRAWER SYSTEM

### GLASS SLIM BOX DRAWER

Height :  
KGSBD - 01 - 84mm  
KGSBD - 03 - 167mm  
KGSBD - 04 - 199mm

Depth :  
400mm, 450mm, 500mm, 550mm

Weight Capacity : 40 kg.  
Colour : Iron Grey/White



### GLASS SLIM BOX DRAWER WITH CONNECTOR

GLASS INNER SLIM BOX DRAWER



KGSBD - 01 GLASS SLIM BOX DRAWER  
KSBA - 10 CONNECTOR  
KSBA - 11 GLASS PANEL  
KSBA - 06 PUMPING PANEL

GLASS SLIM BOX DRAWER WITH HALF GLASS



KGSBD - 03 GLASS SLIM BOX DRAWER  
KSBA - 05 CONNECTOR  
KSBA - 07 GLASS PANEL  
KSBA - 06 PUMPING PANEL

GLASS SLIM BOX DRAWER WITH SQUARE RAILING



KGSBD - 03 GLASS SLIM BOX DRAWER  
KSBA - 03 CONNECTOR  
KSBA - 04 RAILING  
KSBA - 06 PUMPING PANEL

GLASS SLIM BOX DRAWER WITH FULL GLASS



KGSBD - 03 GLASS SLIM BOX DRAWER  
KSBA - 08 CONNECTOR  
KSBA - 09 GLASS PANEL  
KSBA - 06 PUMPING PANEL

## KITCHEN DRAWER ACCESSORIES



### WOODEN ADJUSTABLE CUTLERY

Width x Depth x Height :  
KDA - 01 (315 - 444) X 470 X 52  
KDA - 02 (315 - 444) X 520 X 52  
KDA - 03 (409-538) X 470 X 52  
KDA - 04 (409-538) X 520 X 52  
KDA - 05 (638-836) X 470 X 52  
KDA - 06 (638-836) X 520 X 52

Colour : Beach Wood



### ALU. ADJUSTABLE CUTLERY

Width x Depth x Height :  
KDA - 07 (325-375) X 470 X 55  
KDA - 08 (325-375) X 520 X 55  
KDA - 09 (375-425) X 470 X 55  
KDA - 10 (375-425) X 520 X 55  
KDA - 11 (475-525) X 470 X 55  
KDA - 12 (475-525) X 520 X 55  
KDA - 13 (775-825) X 470 X 55  
KDA - 14 (775-825) X 520 X 55

Colour : Iron Grey



### KTDM-02 DRAWER MATT DOTTED

Description :  
P.V.C. Anti Slip Matt

Length :  
5 Mtr.

Depth :  
470mm, 520mm

Colour : Grey

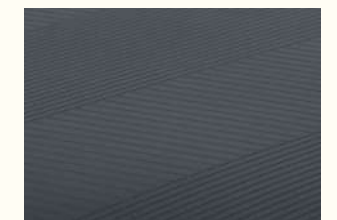

### KTDM-02 DRAWER MATT LINING

Description :  
P.V.C. Anti Slip Matt

Length :  
5 Mtr.

Depth :  
500mm, 550mm

Colour : White



### CUP AND SAUCER HOLDER

Depth :  
KDA - 21 - 470mm  
KDA - 22 - 520mm

Colour : Iron Grey



### PLATE HOLDER

Depth :  
KDA - 23 - 470mm  
KDA - 24 - 520mm

Colour : Iron Grey



### THALI HOLDER

Depth :  
KDA - 25 - 470mm  
KDA - 26 - 520mm

Colour : Iron Grey



## KITCHEN ACCESSORIES

Width x Depth x Height



**KKA - 02 (LEFT-RIGHT)**  
SWING TRAY (SOFT CLOSE)  
Grey Matt  
825 x 370 x 600



**KKA - 03**  
SHOW HAND CORNER  
(SOFT CLOSE)  
Grey Matt  
660 x 485 x 610



**KKA - 04**  
SPACE SWIVAL PULL OUT  
Grey Matt  
(385-450) x 530 x (1920-2220)  
(530-600) x 530 x (1920-2220)



**KKA - 07**  
SPACE SWIVEL PULL OUT  
(GLASS) (SOFT CLOSE)  
380 x 535 x (1720-2020)



**BOTTLE PULL OUT (LEFT-RIGHT)**  
(WITH QUADRO SLIDE)  
Grey Matt  
**KKA - 05** - 160 x 480 x 545  
**KKA - 06** - 260 x 480 x 545



**KKA - 08**  
WASTE BIN  
(WITH QUADRO SLIDE)  
345 x 475 x 440



**KKA - 09**  
ROUND WASTE BIN (14 LTR)  
364 x 364 x 430



**KKA - 10**  
LIQUID DETERGENT HOLDER  
(WITH QUADRO SLIDE)  
285 x 467 x 415

## PREMIUM WARDROBE ACCESSORIES

Finish : High Class Grey



**KWA - 11**

SOFT-CLOSING  
DECORATIONS SHELF

**Width x Depth x Height :**  
864mm x 423mm x 79mm



**KWA - 12**

SOFT-CLOSING TROUSERS  
RACK

**Width x Depth x Height :**  
864mm x 423mm x 79mm



**KWA - 15**

CLOTHES RAIL(SQUARE)

**Width :** 3000mm

**KWA - 16**  
HOLDER FOR CLOTHES  
RAIL(SQUARE)



**KWA - 17**

SOFT-CLOSING LIFTABLE  
HANGER

**Width x Depth x Height :**  
(764-1064)mm x 150mm x 900mm



**KWA - 13**

SOFT-CLOSING GRID  
BASKET

**Width x Depth x Height :**  
864mm x 423mm x 170mm



**KWA - 14**

TOP-INSTALL SOFT-CLOSING  
TROUSERS RACK

**Width x Depth x Height :**  
335mm x 460mm x 126mm



**KWA - 18**

360° ROTATABLE MULTI-TIER  
SHOES RACK 12 LAYERS

**Width x Depth x Height :**  
700mm x 360mm x (1910-2110)mm



**KWA - 19**

ALUMINUM STORAGE BOX

**Width x Depth x Height :**  
140mm x 398mm x 65mm



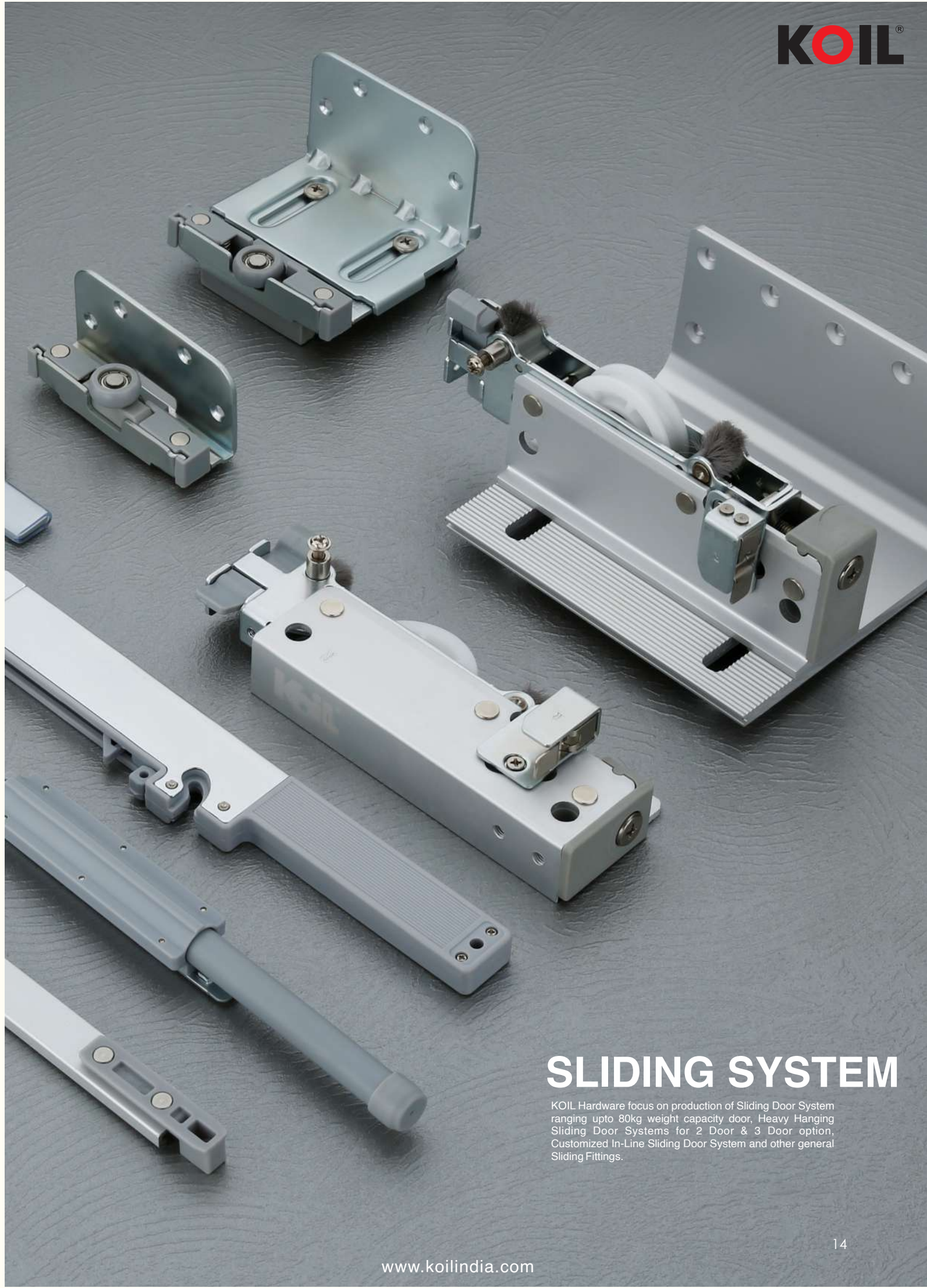

**SLIDING SYSTEM**

KOIL Hardware focus on production of Sliding Door System ranging upto 80kg weight capacity door, Heavy Hanging Sliding Door Systems for 2 Door & 3 Door option, Customized In-Line Sliding Door System and other general Sliding Fittings.

**SLIDING SYSTEM**

**KSLD - 14  
2 WAY SOFT CLOSE**  
(Maximum Door Thickness 22mm)

**Description :**  
8 Roller, 4 Soft Close  
**Weight Capacity :** 50 kg.  
**Finish :** Dark Grey

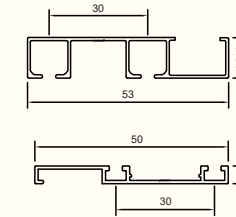

**KSC - 14**  
**Length :**  
8 Feet, 12 Feet  
**Finish :** Alu. Matt,  
Gold Brush, Black Matt

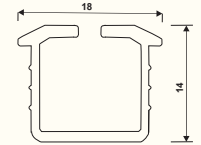

**KSC - 07**  
**Length :**  
8 Feet, 12 Feet  
**Finish :** Alu. Matt

**KSLD - 11  
2 WAY SOFT CLOSE**  
(BACK SCREW)

**Description :**  
8 Roller, 4 Soft Close  
**Weight Capacity :** 50 kg.  
**Finish :** Zinc

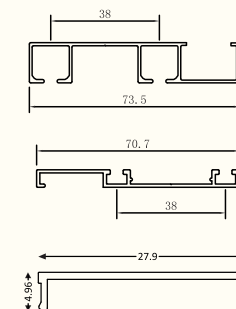

**KSC - 08**  
**Length :**  
8 Feet, 12 Feet  
**Finish :** Alu. Matt,  
Gold Brush, Black matt  
(with cover)

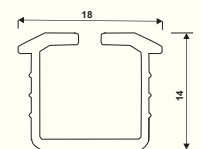

**KSC - 07**  
**Length :**  
8 Feet, 12 Feet  
**Finish :** Alu. Matt



# SLIDING SYSTEM

## KSLD - 09 HEAVY HANGING

**Type :**  
2 Door, 3 Door

**Description :**  
16mm to 46mm Door Thickness

**Weight Capacity :** 80 kg.

**Finish :** Zinc

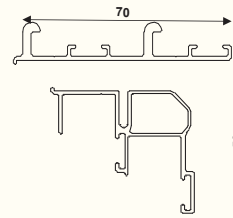

**KSC - 09**  
**Length :**  
10 Feet, 13 Feet  
**Finish :** Alu. Matt

## KSLD - 10 IN-LINE SLIDING

**Description :**  
18mm to 45mm Door Thickness

**Length :** 10 Feet

**Weight Capacity :** 60 kg.

**Finish :** Zinc

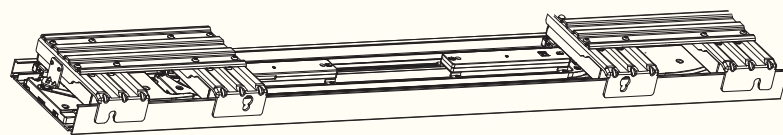

( SIZE CAN BE CUSTOMIZED  
AS PER THE REQUIREMENTS )

# SLIDING SYSTEM

## KSLD - 12 HEAVY DOOR SYSTEM

**Type :** Double Track

**Weight Capacity :** 80 kg.

**Finish :** Zinc

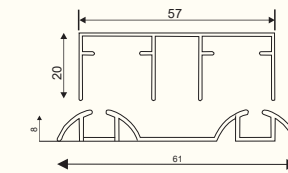

**KSC - 12**  
**Length :**  
8 Feet, 12 Feet  
**Finish :** Alu. Matt



**KSCD - 01 DAMPER**  
Used for Soft Close  
with KSC-22 & KSC-12

## KSLD - 13 HANGING SLIDING ROLLER

(TWO WAY SOFT CLOSE)

**Weight Capacity :** 60 kg.

**Finish :** Zinc

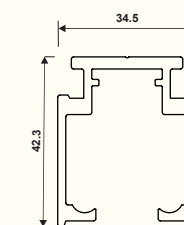

**KSC - 13**  
**Length :**  
8 Feet, 12 Feet  
**Finish :** Alu. Matt



## ALUMINIUM PROFILES & HANDLES

KOIL is a leading provider of aluminium profiles & handle involved in offering best quality of products. Aluminium Profiles & Handles are extensively used as components in enhancing the smart appearance of your Kitchen / Wardrobe / Office interiors. Aluminium Profiles provide a wide range of products with attractive finishes and durability moving a step further beyond customers requirement.



## ALUMINIUM PROFILES



### KSH - 01 DAZZLER SHUTTER HANDLE (SQUARE)

Size in mm :  
275, 475, 625, 750, 925, 1200, 3000 (Left-Right)

Finish : Black Matt,, Glossy, Grey Matt, Gold Brush



### KSH - 02 DAZZLER SHUTTER HANDLE (ROUND)

Size in mm :  
275, 475, 625, 750, 925, 1200, 2700

Finish : Black Matt, Glossy



### KSH - 03 DAZZLER SHUTTER HANDLE (ROUND)

Size in mm :  
625, 925, 1200, 3000 (Left-Right)

Finish : Black Matt, Grey Matt, Gold Brush



### KSP - 01 DAZZLER SHUTTER PROFILE

Size : 3 Mtr.

Finish : Black Matt, Glossy, Matt Grey, Gold Brush



### KAPC - 11 DAZZLER SHUTTER CONNECTOR

Finish : Zinc





# ALUMINIUM PROFILES

Length : 3 Mtr.

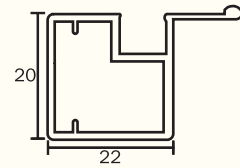

**KAPS-01**  
Frame Profile for 4mm Glass  
**Finish** : Alu. Matt, S.S. Brush, Glossy, Black Matt  
(Use with KAPS-02)

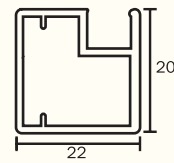

**KAPS-02**  
Frame Profile for 4mm Glass  
**Finish** : Alu. Matt, S.S. Brush, Glossy, Black Matt  
(Use with KAPS-01)

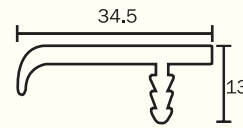

**KAPS-03**  
Handle Profile  
**Finish** : Alu. Matt, S.S. Brush, Glossy, Black Matt

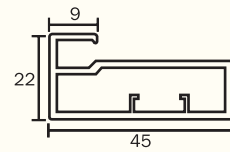

**KAPS-04**  
Frame Profile for 4mm Glass  
**Finish** : Alu. Matt, S.S. Brush, Glossy, Black Matt, Rose Gold, Grey Matt, Gold Brush  
(Use with KAPS-05, 07, 16, 45)

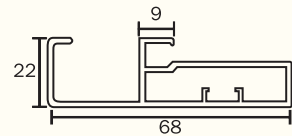

**KAPS-05**  
Frame Profile for 4mm Glass  
**Finish** : Alu. Matt, S.S. Brush, Glossy, Black Matt, Rose Gold, Grey Matt, Gold Brush  
(Use with KAPS-04)

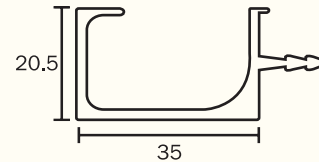

**KAPS-06**  
G Handle Profile  
**Finish** : Alu. Matt, S.S. Brush, Glossy, Black Matt, Rose Gold, Grey Matt

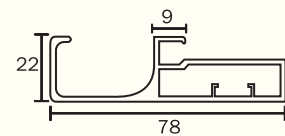

**KAPS-07**  
Frame Profile for 4mm Glass  
**Finish** : Alu. Matt, S.S. Brush, Glossy  
(Use with KAPS-04)

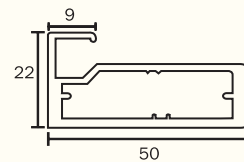

**KAPS-08**  
Frame Profile for 4mm Glass  
**Finish** : Alu. Matt, S.S. Brush  
(Use with KAPS-09)

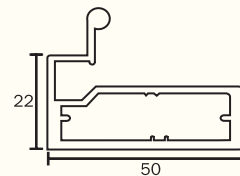

**KAPS-09**  
Frame Profile for 4mm Glass  
**Finish** : Alu. Matt, S.S. Brush  
(Use with KAPS-08)

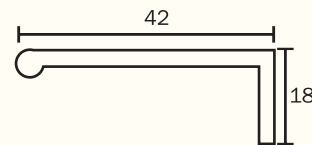

**KAPS-10**  
Handle Profile  
**Finish** : Alu. Matt, S.S. Brush, Glossy, Black matt

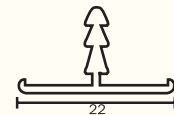

**KAPS-11**  
Edge Profile  
**Finish** : Alu. Matt, S.S. Brush, Glossy, Black Matt

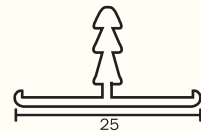

**KAPS-12**  
Edge Profile  
**Finish** : Alu. Matt, S.S. Brush, Glossy, Black Matt

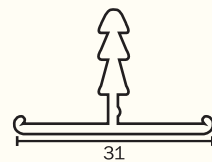

**KAPS-13**  
Edge Profile  
**Finish** : Alu. Matt, S.S. Brush, Glossy, Black Matt

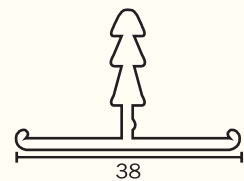

**KAPS-14**  
Edge Profile  
**Finish** : Alu. Matt, S.S. Brush, Glossy, Black Matt

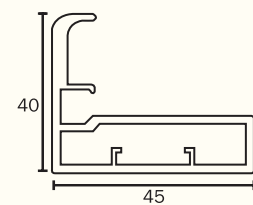

**KAPS-16**  
Frame Profile for 4mm Glass  
**Finish** : Alu. Matt, S.S. Brush, Glossy  
(Use with KAPS-04)

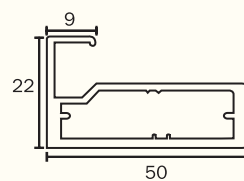

**KAPS-17**  
Frame Profile for 6mm Glass  
**Finish** : Alu. Matt, S.S. Brush, Glossy  
(Use with KAPS-18)

# ALUMINIUM PROFILES

Length : 3 Mtr.

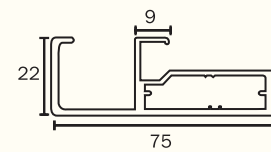

**KAPS-18**  
Frame Profile for 6mm Glass  
**Finish** : Alu. Matt, S.S. Brush, Glossy  
(Use with KAPS-17)

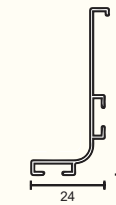

**KAPS-19**  
Gola Profile  
**Finish** : Alu. Matt, S.S. Brush, Glossy, Black Matt

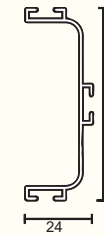

**KAPS-20**  
Gola Profile  
**Finish** : Alu. Matt, S.S. Brush, Glossy, Black Matt

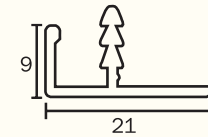

**KAPS-21**  
Edge Profile  
**Finish** : Alu. Matt, S.S. Brush, Glossy

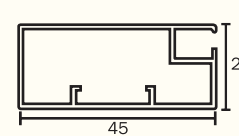

**KAPS-22**  
Frame Profile for 4mm Glass  
**Finish** : Alu. Matt, S.S. Brush, Glossy

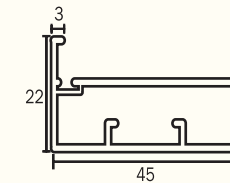

**KAPS-23**  
Frame Profile for 4mm Glass  
**Finish** : Alu. Matt, S.S. Brush, Glossy, Grey Matt, Black Matt  
(Use with KAPS-24)

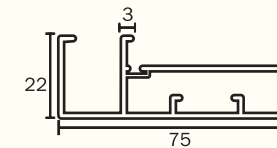

**KAPS-24**  
Frame Profile for 4mm Glass  
**Finish** : Alu. Matt, S.S. Brush, Glossy, Grey Matt, Black Matt  
(Use with KAPS-23)



**KAPS-25**  
6mm T-Profile Heavy  
**Finish** : S.S. Brush

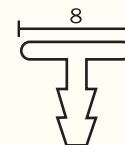

**KAPS-26**  
8mm T-Profile Heavy  
**Finish** : S.S. Brush

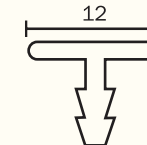

**KAPS-27**  
12mm T-Profile Heavy  
**Finish** : S.S. Brush

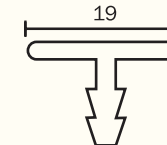

**KAPS-28**  
19mm T-Profile Heavy  
**Finish** : S.S. Brush

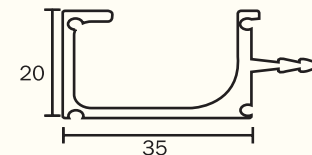

**KAPS-29**  
G-Handle for End Cap  
**Finish** : Alu. Matt, S.S. Brush, Glossy, Black Matt

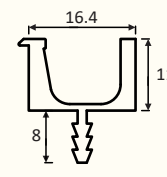

**KAPS-30**  
Aluminium Edge Profile  
**Finish** : Alu. Matt, S.S. Brush, Glossy, Black Matt  
(Use with KAPS-50)

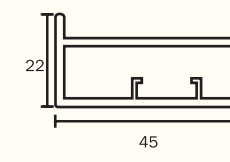

**KAPS-31**  
Frame Profile for 4mm Glass  
**Finish** : Alu. Matt, S.S. Brush, Glossy, Black Matt, Rose Gold Grey Matt  
(Use with KAPS-32)

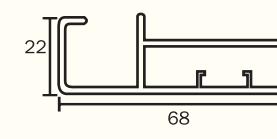

**KAPS-32**  
Frame Profile for 4mm Glass  
**Finish** : Alu. Matt, S.S. Brush, Glossy, Black Matt, Rose Gold Grey Matt  
(Use with KAPS-31)

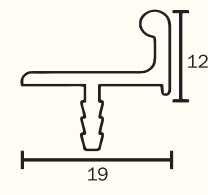

**KAPS-33**  
Handle Profile  
**Finish** : Alu. Matt, S.S. Brush, Glossy



## ALUMINIUM PROFILES

Length : 3 Mtr.

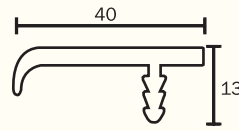

**KAPS-34**  
Handle Profile  
**Finish :** Alu. Matt,  
S.S. Brush, Glossy

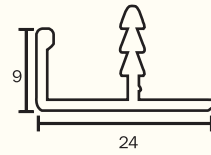

**KAPS-35**  
Edge Profile  
**Finish :** Alu. Matt,  
S.S. Brush, Glossy

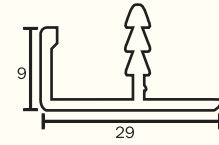

**KAPS-36**  
Edge Profile  
**Finish :** Alu. Matt,  
S.S. Brush, Glossy

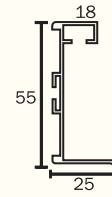

**KAPS-37**  
Gola Profile (LED)  
**Finish :** Alu. Matt,  
S.S. Brush, Black Matt

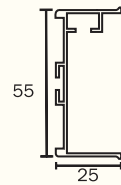

**KAPS-38**  
Gola Profile (LED)  
**Finish :** Alu. Matt,  
S.S. Brush, Black Matt

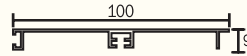

**KAPS-40**  
Skirting Profile  
**Finish :** Alu. Matt,  
S.S. Brush, Black Matt

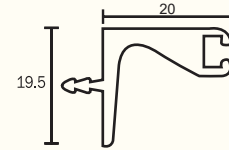

**KAPS-41**  
Handle Profile  
**Finish :** Alu. Matt,  
Black Matt

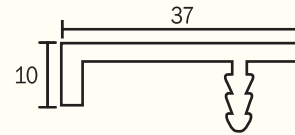

**KAPS-42**  
Handle Profile  
**Finish :** Alu. Matt,  
S.S. Brush, Glossy,  
Black Matt

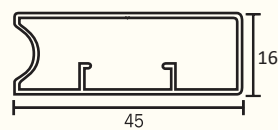

**KAPS-43**  
Frame Profile for 4mm Glass  
**Finish :** Alu. Matt, S.S. Brush,  
Glossy, Black Matt, Rose Gold  
Grey Matt  
(Use with KAPS-44)

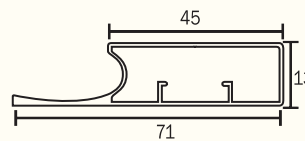

**KAPS-44**  
Frame Profile for 4mm Glass  
**Finish :** Alu. Matt, S.S. Brush,  
Glossy, Black Matt, Rose Gold  
Grey Matt  
(Use with KAPS-43)

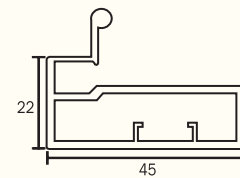

**KAPS-45**  
Frame Profile for 4mm Glass  
**Finish :** Alu. Matt, S.S. Brush,  
Glossy, Black Matt, Rose Gold  
Grey Matt, Gold Brush  
(Use with KAPS-04)

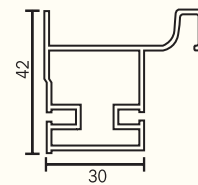

**KAPS-46**  
Vertical Gola Profile  
**Finish :** Alu. Matt,  
S.S. Brush, Glossy,  
Black Matt

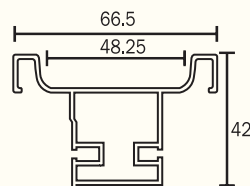

**KAPS-47**  
Vertical Gola Profile  
**Finish :** Alu. Matt,  
S.S. Brush, Glossy,  
Black Matt

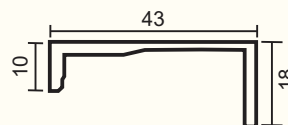

**KAPS-48**  
Handle Profile  
**Finish :** Alu. Matt,  
S.S. Brush, Glossy

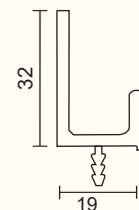

**KAPS-49**  
Handle Profile  
**Finish :** Alu. Matt,  
S.S. Brush, Glossy,  
Black Matt

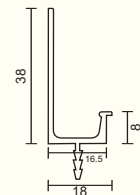

**KAPS-50**  
Handle Profile  
**Finish :** Alu. Matt,  
S.S. Brush, Glossy,  
Black Matt, Gold Brush  
(Use with KAPS-30)

## ALUMINIUM PROFILES

Length : 3 Mtr.

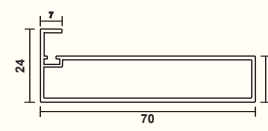

**KAPS-51**  
Frame Profile  
(5mm to 6mm Glass)  
**Finish :** Black Matt

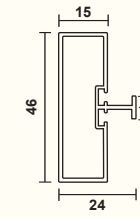

**KAPS-52**  
Frame Profile  
(5mm to 6mm Glass)  
**Finish :** Black Matt

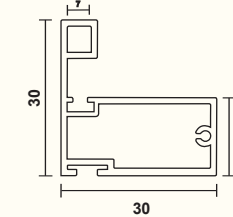

**KAPS-53**  
Frame Profile  
(5mm to 6mm Glass)  
**Finish :** Black Matt

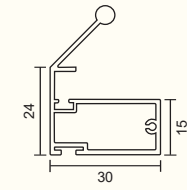

**KAPS-54**  
Frame Profile  
(5mm to 6mm Glass)  
**Finish :** Black Matt

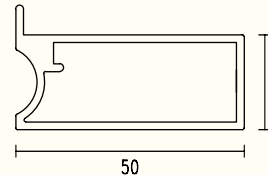

**KAPS-55**  
Frame Profile with Edge  
**Finish :** Alu. Matt, S.S. Brush,  
Black Matt, Rose Gold,  
Gold Brush, Grey Matt  
(Use with KAPS-56)

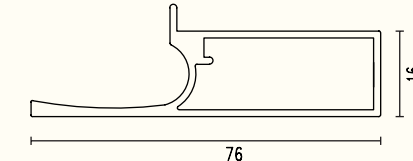

**KAPS-56**  
Frame Profile with Edge  
**Finish :** Alu. Matt, S.S. Brush,  
Black Matt, Rose Gold,  
Gold Brush, Grey Matt  
(Use with KAPS-55)

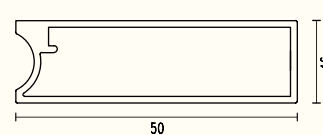

**KAPS-57**  
Frame Profile  
**Finish :** Alu. Matt, Black Matt,  
Rose Gold  
(Use with KAPS-58)

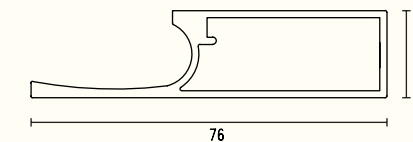

**KAPS-58**  
Handle Profile  
**Finish :** Alu. Matt, Black Matt,  
Rose Gold  
(Use with KAPS-57)

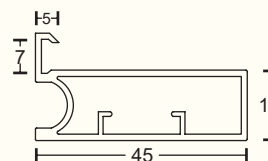

**KAPS-59**  
3mm Edge Frame Profile  
**Finish :** Black Matt,  
Grey Matt, Gold Brush,  
(Use with KAPS-60)

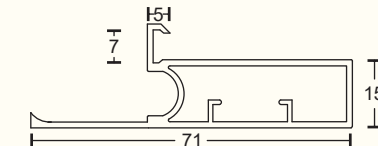

**KAPS-60**  
3mm Edge Handle Profile  
**Finish :** Black Matt,  
Grey Matt, Gold Brush,  
(Use with KAPS-59)



## ALUMINIUM HANDLES

### KCH - 01 CONCEALED HANDLE (SQUARE)

Size in mm :  
96, 160, 224, 288

Finish : S.S. Brush, CP



### KCH - 01 CONCEALED HANDLE (RECTANGLE)

Size in mm :  
96, 160, 224, 288

Finish : S.S. Brush, CP



### KCH - 03 EDGE HANDLE (ROUND)

Size in mm :  
196, 296, 396, 446, 496, 596, 696, 796, 896

Finish : S.S. Brush, CP, Black Matt



### KCH - 03 EDGE HANDLE (SQUARE)

Size in mm :  
196, 296, 396, 446, 496, 596, 696, 796, 896, 3000(Right-Left)

Finish : S.S. Brush, CP, Black Matt



## ALUMINIUM HANDLES

### KCH - 05 EDGE HANDLE (BACK SCREW)

Size in mm :  
128, 224

Finish : S.S. Brush, CP, Black Matt



### KCH - 06 EDGE HANDLE (BACK SCREW)

FOR 25mm THICK DOOR

Size in mm : 600, 1200  
2700 (Left/Right)

Finish : S.S. Brush, Black Matt  
Grey Matt



### KCH - 07 PULL HANDLE (SQUARE)

Size in mm :  
96, 148, 1100

Finish : S.S. Brush, Grey Matt, Black Matt



### KCH - 08 PULL HANDLE (ROUND)

Size in mm :  
128, 256, 1100

Finish : S.S. Brush, Grey Matt, Black Matt



### KCH - 09 ALUMINIUM EDGE HANDLE (SQUARE)

Size in mm :  
298, 398, 498, 598, 698, 798, 898, 3000 (Left/Right)

Finish : Grey Matt, Black Matt, Gold Brush





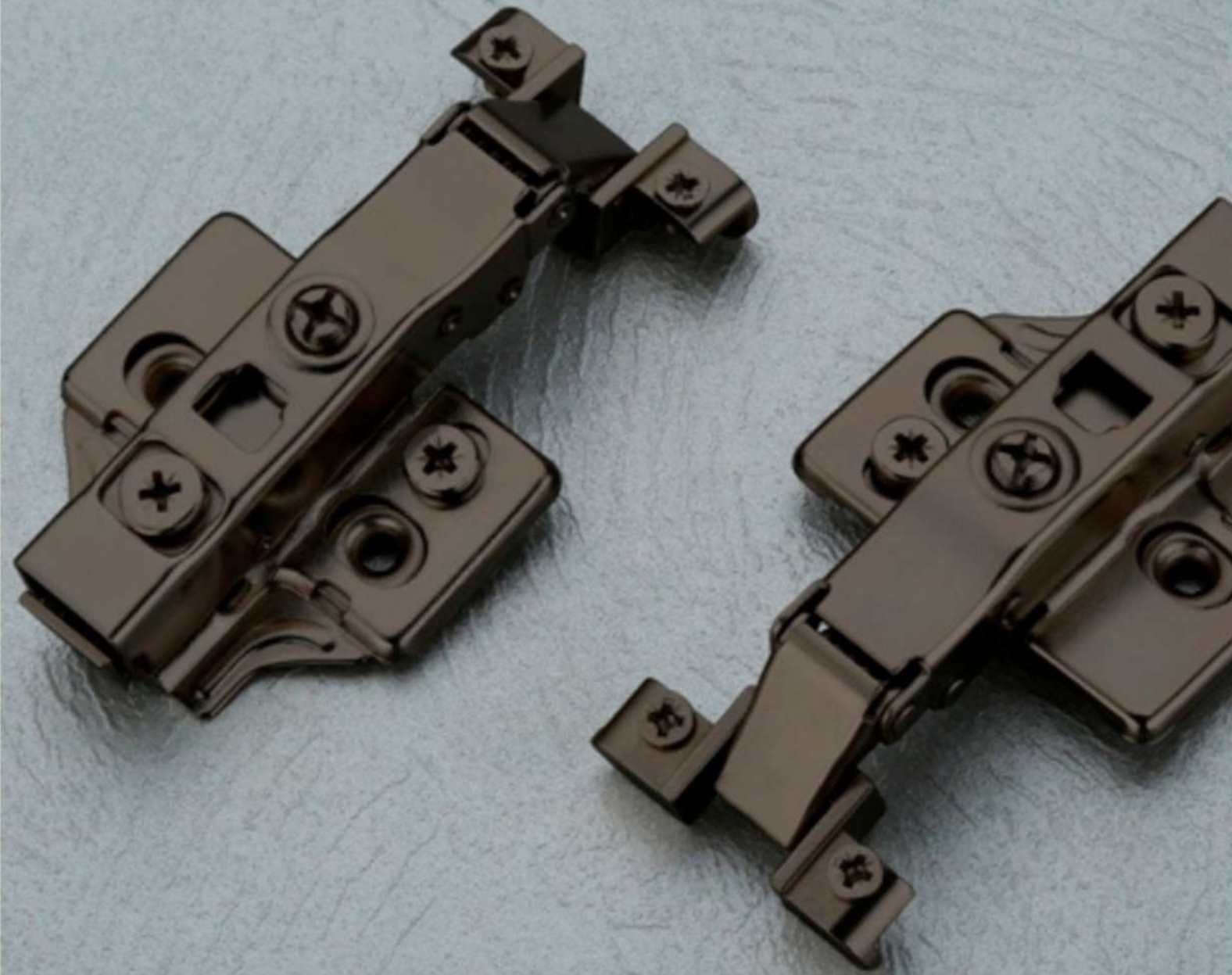

**REGULAR  
HARDWARE PRODUCTS**

KOIL Hardware focus on production of small but important products for general fittings which includes Telescopic Channel / Auto Hinge / Profiles Connector / Bed Fittings enhancing a rich experience with huge range of quality & durable products.

**AUTO  
HINGE**



**KAH - 01**  
SLIDE ON AUTO HINGE  
Crank : 0°, 8°, 16°  
Finish : Zinc



**KAH - 02**  
CLIP ON AUTO HINGE  
(Soft Close)  
Crank : 0°, 8°, 16°  
Finish : Zinc



**KAH - 03**  
CLIP ON THICK DOOR AUTO HINGE  
(Soft Close)  
Crank : 0°, 8°, 16°  
Finish : Zinc, Black matt



**KAH - 04**  
CLIP ON PROFILE AUTO HINGE  
(Soft Close)  
Crank : 0°, 8°, 16°  
Finish : Black Matt



**KAH - 05**  
CLIP ON THICK DOOR AUTO HINGE  
Crank : 0°, 8°, 16°  
Finish : Zinc



**KAH - 06**  
CLIP ON SOFT CLOSE AUTO HINGE  
Crank : 135°  
Finish : Zinc



**KAH - 07**  
CLIP ON SOFT CLOSE AUTO HINGE  
Crank : 30°  
Finish : Zinc



**KAH - 08**  
CLIP ON SOFT CLOSE AUTO HINGE  
Crank : 45°  
Finish : Zinc



**KAH - 09**  
CLIP ON SOFT CLOSE AUTO HINGE  
Crank : 90°  
Finish : Zinc



**KAH - 10**  
CLIP ON SOFT CLOSE AUTO HINGE  
Crank : 165°  
Finish : Zinc



**KAH - 11**  
CLIP ON AUTO HINGE  
(Soft Close) 3D Mounting Plate  
Crank : 0°, 8°, 16°  
Finish : Black Matt



**KAH - 12**  
26mm CUP HINGE  
(Soft Close)  
Crank : 0°, 8°, 16°  
Finish : Black matt



**KAH - 13**  
FACE FRAME HINGE  
(Soft Close)  
Crank : ½ inch, 1 ¼ inch  
Finish : Zinc



**KAH - 14**  
CLIP ON PROFILE AUTO CLOSE HINGES (Soft Close)  
(Soft Close)  
Crank : 0°, 8°, 16°  
Finish : Black matt



## DRAWER CHANNEL

### KTC TELESCOPIC CHANNEL

45MM CHANNEL

**Weight Capacity :** 40 kg  
**Size :** 8" to 36"  
**Finish :** Zinc, Black matt



### KSCC TELESCOPIC SOFT CLOSE CHANNEL

45MM CHANNEL WITH FULL EXTENSION  
50,000 CYCLE TESTED PRODUCT

**Weight Capacity :** 35 kg  
**Size :** 12" to 24"  
**Finish :** Zinc



### KQC QUADRO CHANNEL

SYNCHRONIC SYSTEM  
(SOFT CLOSE SLIDE WITH FULL EXTENSION)

**Weight Capacity :** 40 kg  
**Size :** 12" to 22"



## DOOR STRAIGHTENER (UPTO 22mm THICKNESS)

### KADS-01 DOOR STRAIGHTENER

**Size :** 2.1 MTR, 2.4 MTR  
**Finish :** Dark Grey

### KADS-02 ADJUSTMENT TAB

ROUTER BIT FOR KADS-01



28

## GAS SPRING



**KGS - 01**  
GAS SPRING FOR FURNITURE  
**Size :** 9"  
**Capacity :** 5Kg., 10Kg., 15Kg., 20Kg.  
**Finish :** White



**KGS - 02**  
GAS SPRING FOR FURNITURE  
**Size :** 12"  
**Capacity :** 15Kg., 20Kg., 25Kg., 30Kg., 35Kg.  
**Finish :** White



**KGS - 06**  
GAS SPRING FOR BED FRAME  
**Size :** 24"  
**Capacity :** 50Kg., 75Kg., 100Kg.  
**Finish :** White



**KGS - 08**  
GAS SPRING FOR BED FRAME  
**Size :** 416mm  
**Capacity :** 75Kg., 100Kg., 120Kg., 150Kg.  
**Finish :** Black



**KGS - 09**  
GAS SPRING FOR BED FRAME  
**Size :** 416mm  
**Capacity :** 175Kg., 200Kg., 250Kg.  
**Finish :** Black



**KGS - 11**  
GAS SPRING WITH SOFT CLOSE  
**Size :** 12"  
**Capacity :** 5Kg, 10Kg, 15Kg.  
**Finish :** White

## BED PRO LIFT FITTING

**KGS - 10 HEAVY**  
M.S. BED FRAME (5mm)  
**Size :** 5 Feet  
**Finish :** Black PC

**For Gas Spring :**  
75 Kg., 100 Kg., 120 Kg., 150 Kg.,  
175 Kg., 200 Kg., 250 Kg.



29



## CABINET SUPPORT



**KCF - 01**  
CABINET SUPPORT  
(Left/Right)  
Finish : Grey



**KCF - 02**  
CABINET STAY  
(UP/Down)  
Finish : Zinc



**KCF - 03**  
CABINET FITTING  
(Magnetic)  
Finish : Gray



**KCF - 04**  
HEAVY CABINET FITTING  
(Magnetic)  
Finish : Gray



**KCF - 05**  
HEAVY CABINET FITTING  
(Push/Pull)  
Finish : S.S.



**KCF - 06**  
HEAVY CABINET FITTING  
(Use with Soft Close Auto Hinge)  
Finish : Zinc

## ALU. VENTILATION GRILL

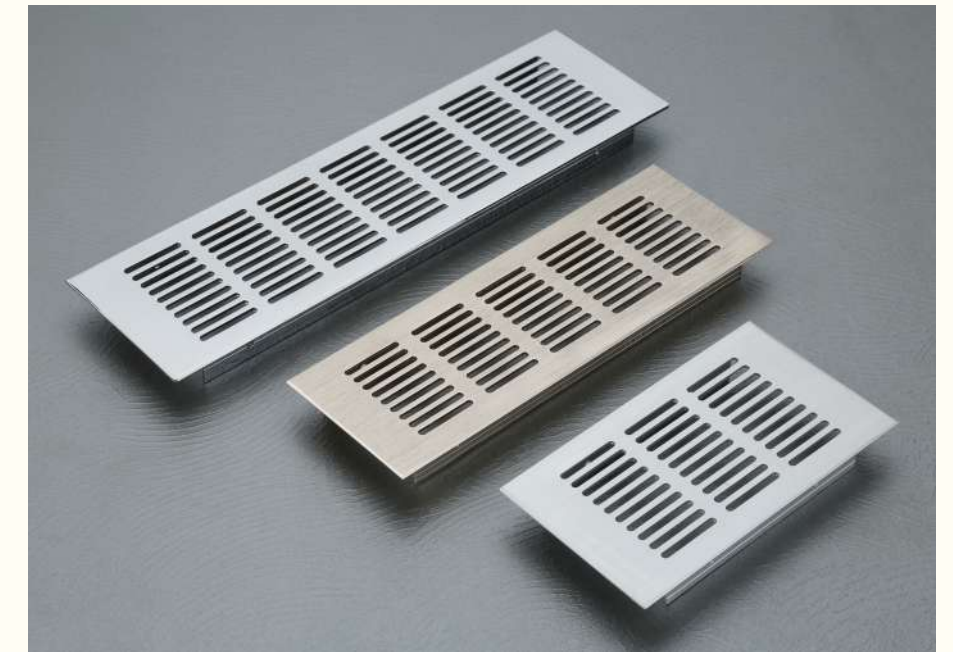

**DECORATIVE GRILL**  
Size in mm :  
86 x 150, 86 x 225, 86 x 300

Finish : Alu. Matt,  
S.S. Brush, CP

**KOIL**<sup>®</sup>

KOIL Hardware Pvt. Ltd.

03/A, Ground Floor, Pinnacle Business Park  
Corporate Road, Prahladnagar, Ahmedabad 380015

Email: [info@koilindia.com](mailto:info@koilindia.com)