

Signature Collection - Aluminum Profile & Shelf System
Product Catalogue



**THE ART
WE OWN**



About Us

For over 13 years, KOIL has been leading the field of Aluminium & Hardware with constant improvement, groundbreaking innovation, and the latest technology.

Renowned for our commitment to exponential growth, we are the preferred end-to-end solution provider for architects and interior designers across India. Our devoted & passionate team blends creativity with technological expertise seamlessly to deliver unparalleled design solutions.

In recent years, we have expanded into complete glass solutions, offering unmatched quality and precision by our proficient team.

Our aim lies in pushing boundaries by developing ingenious, aesthetically exclusive ideas while ensuring maximum reliability for our clients.

Why Choose Us?

Unmatched Quality

Market Leadership

Pioneering Innovation

Cutting-Edge Technology

Finesse in every Detail

Highly Skilled Team

Exceeding Customer Expectations

This is our culture.
This is us.

ALUMINUM PROFILES & SHELF SYSTEM

08

Hand Grip
Series

10

Verve
Series

12

Fab-oval
Series

14

Stellar
Series

16

Stellar Pro
Series

18

Vertiko
Series

20

Slim-fit
Series

22

Easy Rack
Series

24

Spark Shelf
Series

26

Ignite Sensor
Series

28

Sky Line
Series

30

Italiano Shutter
Series

32

Eco-Linear
Series

34

Pheonix
Series

36

Kitchen
Handle

38

Solaris
Series

40

Mid-fit Space
Series

42

Kristal
Series

44

Glider
Leg

Signature Collection

Minimalist style design is a Kind of pursuit
of perfect life attitude it is a concept of life in
pursuit of taste

Index

HAND GRIP SERIES

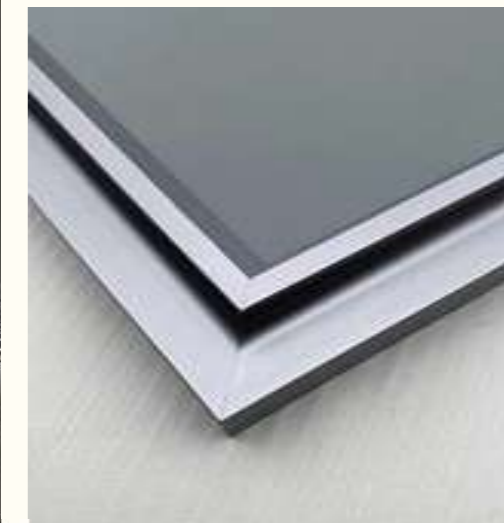

KAH - 12
26mm Cup Hinge (Soft Close)
Crank : 0°, 8°, 16°
Finish : Black



HAND GRIP SERIES

4mm Glass

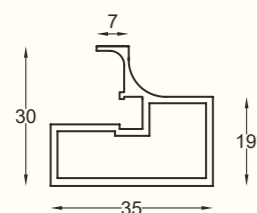

SCP - 01
All Side Handle Profile
Size : 3 mtr.
Finish : Black Matt, Grey Matt

Hand Grip Series gives a contemporary reinterpretation of classic furniture like sideboards, cabinets and drawer units. This collection is characterized by the particular structure by exclusive design details, by the mechanisms of movement and with in-built Handle option in the profile itself.



VERVE SERIES

4mm Glass

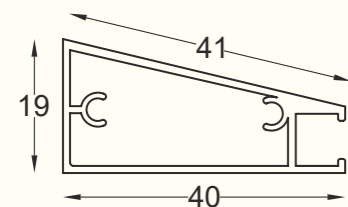

SCP - 02
Slant Profile
Size : 3 mtr.
Finish : Black Matt, Grey Matt, Gold Brush

Verve Series provides a Concise Style Glass Doors that can be used as a Cabinet or Central tall units with tip-on opening options on Top Bottom. Sleek & Slant combination with profile handle been integrated into frame upright with Standard size of 200mm gives the most unique feature as not found anywhere.

VERVE SERIES



SCPH - 02 - 02
Profile Handle Accessories
Size : 150mm
Finish : Black Matt, Grey Matt, Gold Brush



SCPH - 02 - 01
Top - Bottom Profile
Size : 400mm, 450mm, 600mm
Finish : Black Matt, Grey Matt, Gold Brush



KAH - 12
26mm Cup Hinge (Soft Close)
Crank : 0°, 8°, 16°
Finish : Black



FAB-OVAL SERIES

4mm Glass

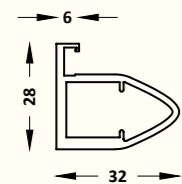

SCP - 03
Oval Shape Profile
Size : 3 mtr.
Finish : Black Matt, Grey Matt

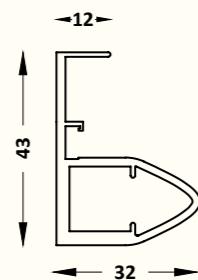

SCPH - 03
Oval Shape Profile Handle
Size : 2.7 mtr. (Handle Size : 200mm)
Finish : Black Matt, Grey Matt

Fab-Oval glass swing door used in modern days wardrobe design for clothes cabinet or Walking Wardrobes & Glass Cabinets with only Top & Bottom Air Hinges with 18kgs approx weight capacity. Oval Shape Profiles will bring a standard look at your wardrobe with only 200mm sized handle displayed over it.

FAB-OVAL SERIES



SCPA - 03
Air Hinges



SCPC - 03
"L" Connector For Air Hinges
Finish : Zinc



STELLAR SERIES

4mm Glass

Stellar Series Profile Doors defines that Simplicity is not simple, but its design is simple. Profile has a streamlined shape design, Square in shape with a minimum surface. Air Hinges only at the Top & Bottom of the Wardrobe makes the cabinet timelessly classic.

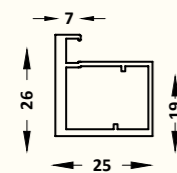

SCP - 04
Square Shape Profile
Size : 3 mtr.
Finish : Black Matt, Gold Brush,
Grey Matt

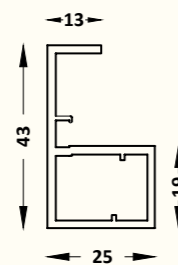

SCPH - 04-01
Square Shape Profile Handle
Size : 3 mtr. Left/Right
(Handle Size : 200mm)
Finish : Black Matt, Gold Brush,
Grey Matt

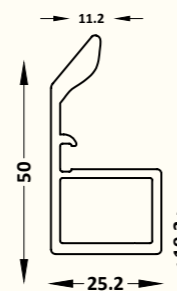

SCPH - 04-04
Slant Square Shape Profile Handle
Size : 3 mtr. Left/Right
(Handle Size : 1100mm)
Finish : Black Matt, Gold Brush,
Grey Matt

STELLAR SERIES



SCPC - 03
Air Hinges
(20KG Weight Capacity)



SCPA - 03
"L" Connector For Air Hinges
Finish : Zinc



SCPH - 04 - 02
Horizontal Handle For SCP-04
Finish : Black Matt, Gold Brush,
Grey Matt



SCPH - 04 - 03
Vertical Handle For SCP-04
Finish : Black Matt, Gold Brush,
Grey Matt



KAH - 14
21mm-25mm Clip On Profile Hinges
Crank : 0°, 8°, 16°
Finish : Black



STELLAR PRO SERIES

4mm Glass

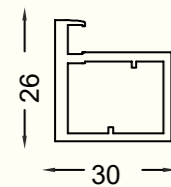

SCP - 31
 Frame Profile
 Size : 3 mtr.
 Finish : Black Matt, Gold Brush

A cutting-edge solution that offers unmatched clarity, durability, and safety. With advanced energy efficiency, versatile applications, and easy maintenance, this glass redefines aesthetics and functionality. Elevate your space and embrace the future of design with the Stellar Pro Series 4mm Glass.

STELLAR PRO SERIES



SCPH - 31
 CNC Handle (Size 125mm)
 Finish : Black Matt, Gold Brush



SCPA - 31
 Heavy Air Hinges
 (30KG Weight Capacity)
 Finish : Black Matt



SCPC - 31
 Connector
 Finish : Zinc



VERTIKO SERIES

18mm Door

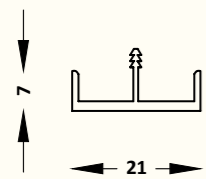

SCP - 05
Wooden Door Profile (For 18mm)
Size : 3 mtr.
Finish : Black Matt, Gold Brush

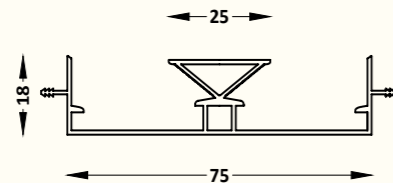

SCPH - 05
Wooden Door Profile Handle
Size : 3 mtr.
Finish : Black Matt, Gold Brush

Vertiko Series creates the choice of every kind of 18mm Finished material with Adorable Horizontal Handle in its centre. Having its multi Purpose uses may you use it for Swing as well as Sliding doors, so can call it beautiful beyond compare.

VERTIKO SERIES



SCPH (A) - 05
Leather Strip
Size : 1.2 mtr.
Finish : Orange, Grey

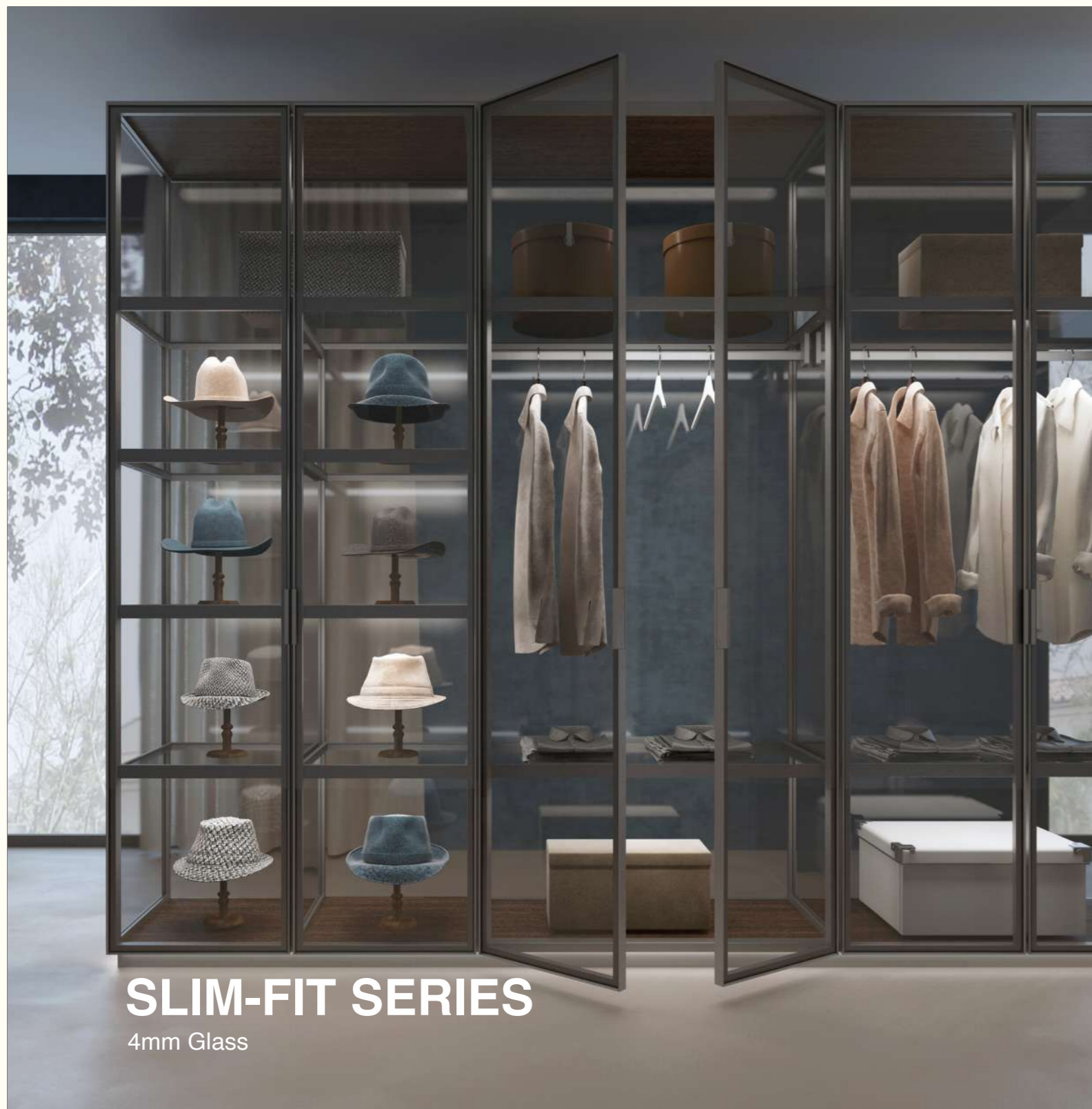

SLIM-FIT SERIES

4mm Glass

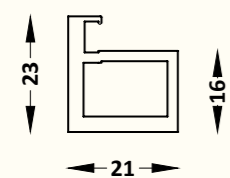

SCP - 06
20mm Square Profile
Size : 3 mtr.
Finish : Black Matt, Gold Brush,
Grey Matt

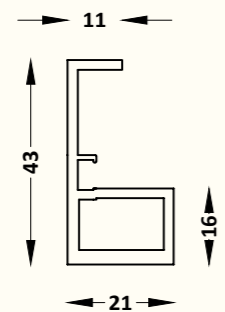

SCPH - 06 - 01
20mm Square Profile Handle
Size : 3 mtr. Left/Right
(Handle Size : 200mm)
Finish : Black Matt, Gold Brush,
Grey Matt

Slim-Fit Series provided horizontal and vertical opening cabinets with a collection of finished units, natural evolution of the modular wardrobe system. This 20mm Slim identity is defined by additional handle options that can be vertically used diving your cabinet into two portions adding beauty to your dignity & achievements.

SLIM-FIT SERIES



SCPH - 06-02
Profile Handle Accessories
Size : 600mm
Finish : Black Matt, Gold Brush



SCPH - 06-03
Profile Handle Accessories
Size : 600mm
Finish : Black Matt



SCP - 06 - 04
Horizontal Handle For SCP-04
Finish : Black Matt, Gold Brush,
Gray Matt



SCPH - 06 - 05
Vertical Handle For SCP-04
Finish : Black Matt, Gold Brush,
Gray Matt



KAH - 04
Clip On Profile Auto Close
Crank : 0°, 8°, 16°
Finish : Zinc, Black



KAH - 14
21mm-25mm Clip On Profile Hinges
Crank : 0°, 8°, 16°
Finish : Black



EASY RACK SERIES

Easy Rack Series pursue from simple to extreme, giving people a sense of simplicity and neatness. Cleanliness, pure colour, present the beauty of the structure itself. Profile Mould has been developed in such a way that any 4mm / 18mm product can be used herein. Also No visible screws, its End Cap as well as Plinth screw give a complete solution to unthinkable variety of designs.

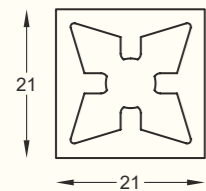

SCP - 07 - 01
Sticking Profile (Vertical)
Size : 3 mtr.
Finish : Black Matt

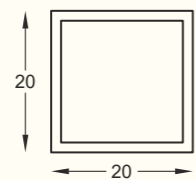

SCP - 07 - 02
Sticking Profile (Hollow)
Size : 3 mtr.
Finish : Black Matt

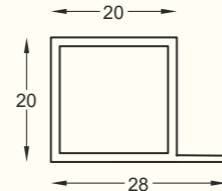

SCP - 07 - 03
Sticking Profile (18mm Product)
Size : 3 mtr.
Finish : Black Matt

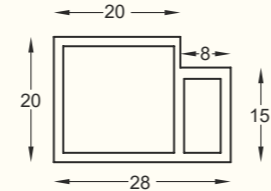

SCP - 07 - 04
Sticking Profile (4mm Product)
Size : 3 mtr.
Finish : Black Matt

EASY RACK SERIES





SPARK SHELF SERIES

Spark Shelf Series is a modular concept of LED Glass Shelf that allows to create single or four-sided Led Effect, most commonly used in Glass Cabinets / Wardrobes. A versatile project, based on horizontal modularity, with set of LED drivers and other solutions that are completely covered within the profile itself, and also available for wooden open LED modules.

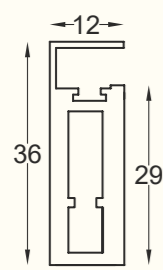

SCP - 08 - 01
Glass Shelf Profile
Size : 3 mtr.
Finish : Black Matt, Gold Brush, Grey Matt

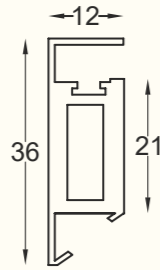

SCP - 08 - 02
Glass Shelf Profile LED
Size : 3 mtr.
Finish : Black Matt, Gold Brush, Grey Matt

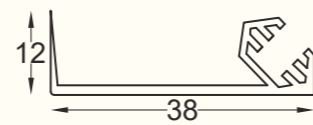

SCP - 09
Wooden Shelf Profile LED
Size : 3 mtr.
Finish : Black Matt, Gold Brush, Grey Matt

SPARK SHELF SERIES



SCPC - 08 - 02
Shelf Support
Finish : Black



SCPC - 08 - 04
LED Stripe
Size : 1 mtr., 2mtr.



IGNITE SENSOR SERIES



Ignite Sensor Series at the other section provides two types of LED Lights that are most commonly used in Kitchens, one consist of Motion Sensor Cabinet LED, majorly used in Overheads which creates a magic of light from your hands while another one consists of IR Sensor Drawer Led which by its name suggest its uses in Drawers cabinets, This days are used in Wardrobes as well...

IGNITE SENSOR SERIES



SCCL - 01
Motion Sensor Cabinet LED
Size : 600mm, 900mm

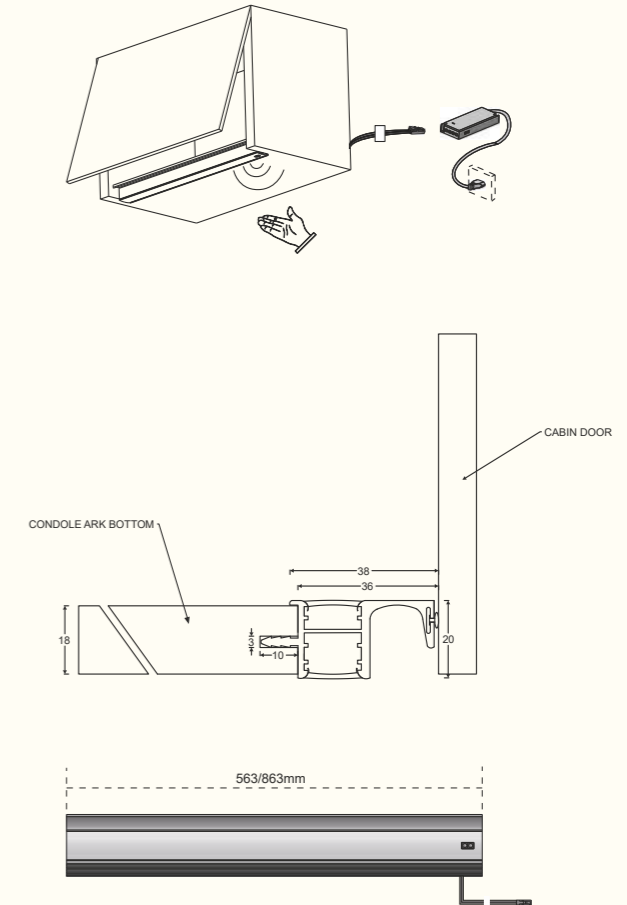

SCCL - 02
IR Sensor Drawer LED
Size : 600mm, 900mm



SCCL - 03
LED Driver (Transformer)
Capacity : 30 Watt, 60 Watt

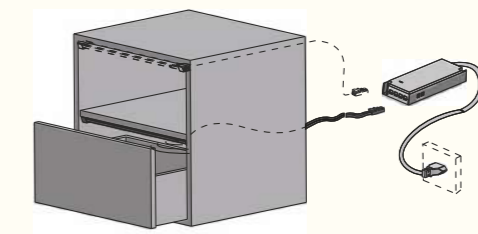



SKY LINE SERIES

Sky Line Series provides a perfect solution to the limitation to top bottom Pivot Hinged doors. Sky Line Series Pivot Hinged on the Top & Bottom will allow to make the maximum heighted doors as per your custom requirement. An opening of 180° of the door, its invisible Mechanism display and the slimmest profile look for the profile is what every modern interior and architects asks for and is preferred as the most demanded modular concept.

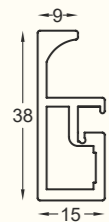

SCP - 11
Pivot Type Handle Profile
Size : 3 mtr.
Finish : Black Matt,
Champagne Gold

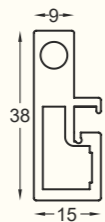

SCP - 12
Pivot Type Side Profile
Size : 3 mtr.
Finish : Black Matt,
Champagne Gold

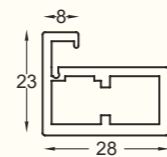

SCP - 13
Pivot Type Top Bottom Profile
Size : 3 mtr.
Finish : Black Matt,
Champagne Gold

SKY LINE SERIES





ITALIANO SHUTTER SERIES

Italiano Shutter Series functions all about when luxury meets modular concept. The immense combination of profile shutters with an option of lacquered glass or laminate added with three different handle options results into a high performing modern kitchen characterized by compositional versatility and a perfect coherence of style.

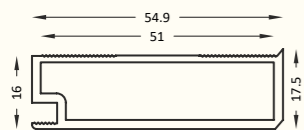

SCP - 14
Side Profile
Size : 3 mtr.
Finish : Black Matt,
Grey Matt

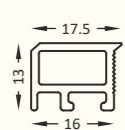

SCP - 15
Bottom Profile
Size : 3 mtr.
Finish : Black Matt,
Grey Matt

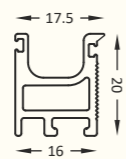

SCP - 16
Handle Profile
Size : 3 mtr.
Finish : Black Matt,
Grey Matt

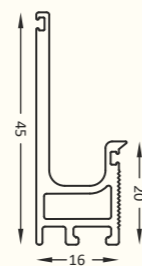

SCP - 17
Handle Profile
Size : 3 mtr.
Finish : Black Matt,
Grey Matt

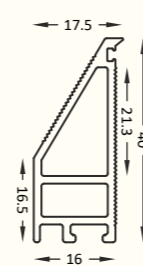

SCP - 18
Handle Profile
Size : 3 mtr.
Finish : Black Matt,
Grey Matt

ITALIANO SHUTTER SERIES





ECO- LINEAR SERIES

Eco Linear Series Wardrobes stand tall, all the way to the ceiling, with combinations of any 6mm finished products divided with slim lines that form a design pattern on a contrasting background. A true designer strokes that will nudge your imagination.

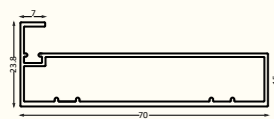

SCP - 21
Frame Profile
Size : 3 mtr.
Finish : Black Matt, Gold Brush, Grey Matt

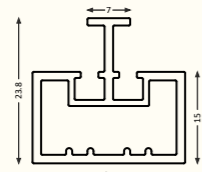

SCP - 22
Divider Profile
Size : 3 mtr.
Finish : Black Matt, Gold Brush, Grey Matt

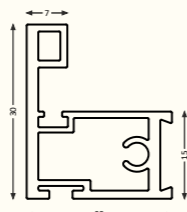

SCP - 23
Handle Profile
Size : 3 mtr.
Finish : Black Matt, Gold Brush, Grey Matt

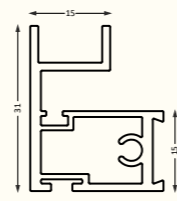

SCP - 24
Handle Profile
Size : 3 mtr.
Finish : Black Matt, Gold Brush, Grey Matt

ECO- LINEAR SERIES





PHEONIX SERIES

Pheonix Series sleek and sophisticated door system for your wardrobes features a hidden structure mechanism with stable weight capacity, soft close working as well as 180° swing option.

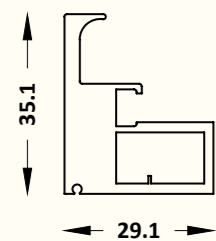

SCP - 26
Handle Profile
Size : 3 mtr.
Finish : Black Matt, Gold Brush, Grey Matt

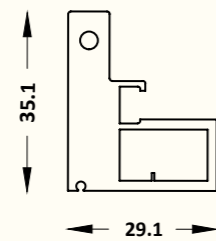

SCP - 27
Side Profile
Size : 3 mtr.
Finish : Black Matt, Gold Brush, Grey Matt

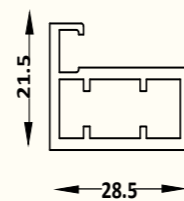

SCP - 28
Top Bottom Profile
Size : 3 mtr.
Finish : Black Matt, Gold Brush, Grey Matt

PHEONIX SERIES



SCPC - 26
Connector For SCP - 26/27/28
Finish : Zinc



SCPA - 26
180° Pin Hinges For SCP - 27
Finish : Black Matt, Grey Matt, Gold Brush

KITCHEN HANDLE

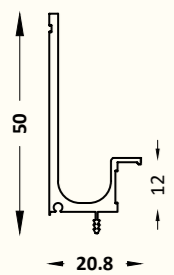

SCP - 19
Alu "J" Edge Profile Handle
Size : 3 mtr.
Finish : Black Matt



SCPC - 19
End Cap for SCP - 19
Finish : Black Matt

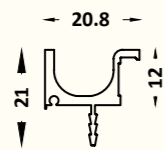

SCP - 20
Alu "C" Edge Profile Handle
Size : 3 mtr.
Finish : Black Matt



SCPC - 20
End Cap for SCP - 20
Finish : Black Matt

KITCHEN HANDLE

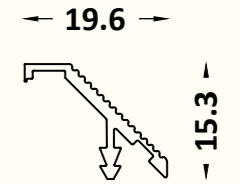

SCP - 29
Alu Cross Edge Profile
Size : 3 mtr.
Finish : Black Matt



SCPC - 29
End Cap for SCP - 29
Finish : Black Matt

PVC DUST STRIPE

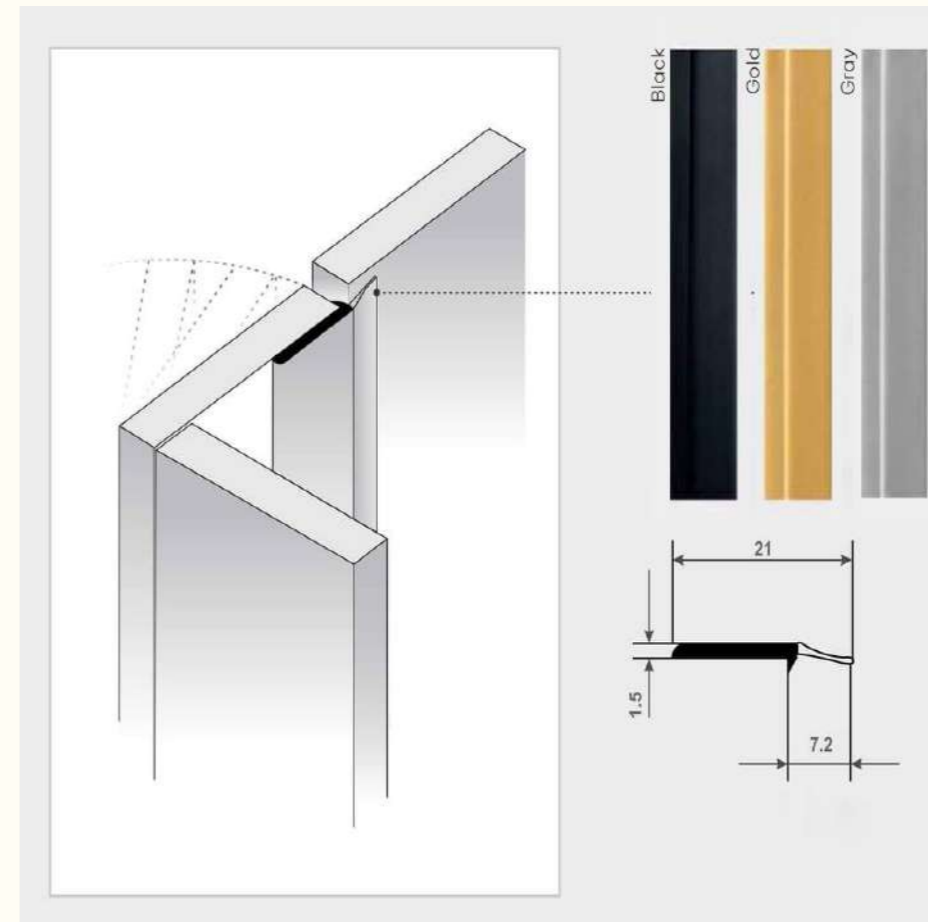

Product Code: SCPA-01
Profile Edge 21mm PVC Door Stripe
with adhesive tape of 9mm
Finish : Black Matt, Gold Matt,
Gray Matt



SOLARIS SERIES

SOLARIS SERIES

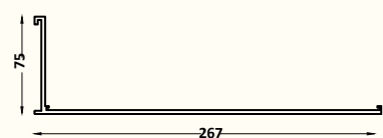

SCP - 91
Aluminium Shelf Profile
Size : 3 mtr.
Finish : Black Matt

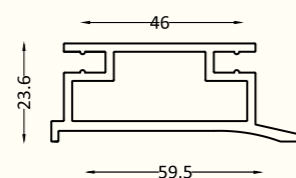

SCP - 92
Shelf Support Profile
Size : 3 mtr.
Finish : Black Matt

Solaris Series gives an innovative wall shelving system in only 8 mm, the design combines a Black aluminium frame, blending aesthetic variety and maximum reliability. The wall fixing system, ensures installation with no visible screws, includes a led lighting system from Top-Bottom Vision.



MID-FIT SPACE SERIES

Mid-Fit Space Series discover a new design to the kitchen hanging Accessories that are enriched by its precious finish and invisible effect of LED light. Aluminum based customised design with the highly standardized Glass Holder perfectly merges the appearance and excellent performing kitchen that meets all its tastes.

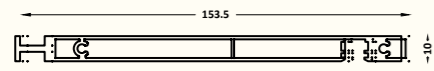

SCP - 95
Divider Profile
Size : 3 mtr.
Finish : Black Matt

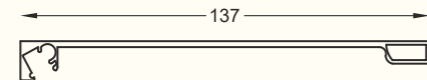

SCP - 98
Top Bottom LED Profile
Size : 3 mtr.
Finish : Black Matt



SCP - 99
Round Support Profile
Size : 3 mtr.
Finish : Black Matt

--12--

MID-FIT SPACE SERIES



SCP - 100
Wine Glass Holder
Size : 600 x 120 mm
Finish : Black Matt



KRISTAL SERIES

4mm Glass

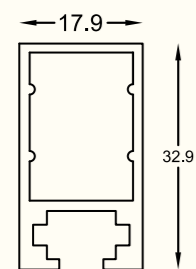

SCP - 87
 Cabinet Slim Profile
 Size : 3 mtr.
 Finish : Black Matt, Gold Brush

Kristal Series covers freestanding & self-standing version of the Glass Wardrobe system, equipped with sides and back Glass Panels, in order to allow the creation of perfectly tailored linear or corner compositions, with integrated access to your areas which also allows a free layout that could be modified any time easily.

KRISTAL SERIES





GLIDER LEG

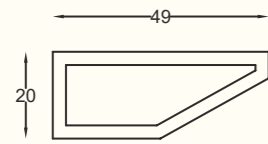

SCP - 86
Aluminium Leg Profile
Size : 3 mtr.
Finish : Black Matt

Glider Leg Series is the base of any modular structure consist of extremely heavy alluminium which provides an exclusive solutions to ensure the maximum reliability with minimum thickness. Glider Leg Series exactly expresses the project research that join the aesthetic originality with the technological innovation.

GLIDER LEG



SCPC - 81
Cabinet Leg
Finish : Black Matt





EUREKA LEATHER SERIES



SCPH - 32
180mm Square Handle
Finish : Black Matt

Bespoke wardrobe with leather doors. Bespoke wardrobe with lavish, sophisticated aesthetics, particularly the stunning natural leather used for the door panels. The sartorial quality of the stitching helps to emphasise the subtle padding provided by the leather, creating asymmetrical graphic patterning which brings dynamism to the surface. The 180mm aluminium handles, set into the doors themselves, contribute to the refined feel of the model.

EUREKA LEATHER SERIES

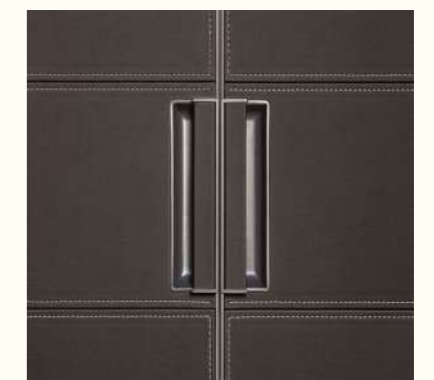



KOIL Hardware Pvt. Ltd.

03/A, Ground Floor, Pinnacle Business Park
Corporate Road, Prahladnagar, Ahmedabad 380015

Email: info@koilindia.com